

2024/2025

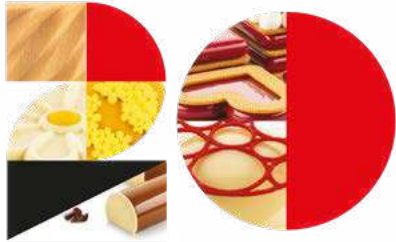

silikomart[®]
MADE IN ITALY





MANIFESTO

Diamo forma alle tue emozioni.

La passione per l'arte della pasticceria è il nostro DNA.

L'innovazione è il nostro modo di pensare al mondo.

Il Made in Italy è il nostro credo.

L'essere una grande famiglia la nostra forza. Da più di 20 anni.

Disegniamo forme d'avanguardia per la pasticceria che vogliamo spingere verso nuove frontiere.

Esploriamo nuovi territori, spostiamo i limiti del realizzabile per creare le nuove forme del gusto.

Siamo al fianco dei pionieri di quest'arte. Trasformiamo il genio creativo dei più grandi maestri pasticceri contemporanei in opere d'arte straordinarie e rivoluzionarie.

Design italiano e produzione italiana: un connubio unico, garanzia di qualità ed eccellenza in tutto il mondo.

Un team appassionato di persone per ispirare la tua creatività e darle forma.

MANIFESTO

We shape your emotions.

The passion for the art of pastry-making is in our DNA.

Innovation is the way we think about the world.

Made in Italy is our belief.

Being a big family is our strength. For over 20 years.

We design avant-garde pastry-making moulds that we hope to push towards new frontiers.

Furthermore, we enter uncharted territories and move the limits of what can be done to create new ways of baking.

Silikomart supports the pioneers of this art. We transform the creative genius of some of the greatest pastry chefs of our time into extraordinary and revolutionary works of art.

Italian design and production: a unique combination and a guarantee of quality and excellence throughout the world.

A passionate team of people here to inspire your creativity and shape it.

MANIFESTO

Nous donnons forme à vos émotions.

La passion pour l'art de la pâtisserie est dans notre ADN.

L'innovation est notre mode de penser au monde.

Le Made in Italy est notre credo.

Être une grande famille est notre force. Depuis plus de 20 ans.

Nous dessinons des formes à l'avant-garde pour la pâtisserie que nous voulons pousser vers de nouvelles frontières.

Nous explorons de nouveaux territoires, nous déplaçons les limites de ce qui est réalisable pour créer les nouvelles formes du goût.

Nous sommes aux côtés des pionniers de cet art. Nous transformons le génie créatif des plus grands maîtres pâtisseries contemporains en œuvres d'art extraordinaires et révolutionnaires.

Design italien et production italienne : une combinaison unique, une garantie de qualité et d'excellence dans le monde entier.

Une équipe passionnée de personnes pour inspirer votre créativité et lui donner forme.



L'ORIGINALE SILICONE PLATINUM SILIKOMART THE ORIGINAL SILIKOMART PLATINUM SILICONE LE VRAI SILICONE PLATINUM SILIKOMART



- **Silicone platinum alimentare di qualità premium.** Top quality food grade platinum silicone. Silicone platinum alimentaire de qualité premium.



- **100% sicuro per la salute.** 100% safe for health. 100% sûr pour la santé.



- **Resistenza termica.** Heat resistance. Résistance thermique.



- **Facile da pulire.** Easy to wash. Facile à nettoyer.



- **Infrangibile.** Unbreakable. Incassable.



- **Salvaspazio.** Space-efficient. Peu encombrant.



- **Riutilizzabile.** Re-usable. Réutilisable.
- **3000 cotture garantite.** 3000 guaranteed baking. 3000 cuissons garanties.



- **BPA Free.**



Effetto 3D
3D effect
3D effet

MATERIALI INNOVATIVI - INNOVATIVE MATERIALS - MATÉRIAUX INNOVANTS

T PLUS+

La nuova tecnologia **Tplus+** di Silikomart per realizzare stampi fatti di un materiale totalmente fornabile.
The new **Tplus+** technology by Silikomart has been used to develop moulds made of a special oven-ready material.
La nouvelle et innovante technologie **Tplus+** de Silikomart a permis de créer des moules avec un matériau complètement fournable.

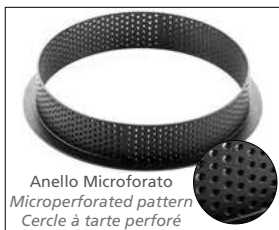

- + Materiale di altissima qualità resistente ad alte temperature (fino a 180°C).

High quality material resistant to high temperatures (up to 356°F).

Matériau de haute qualité résistant aux températures élevées (jusqu'à 180°C).

- + Facile sformatura grazie alle proprietà antiaderenti del materiale.

Easy unmoulding thanks to the non-stick characteristics of the material.

Facile à démouler grâce aux propriétés anti-adhésives du matériau.

- + Lavabile in lavastoviglie, lo stampo rimane inalterato.

Dishwasher safe, the mould remains unaltered.

Lavable au lave-vaisselle, le moule reste inchangée.



- + Può essere usato direttamente in forno, per una riuscita della forma precisa al 100%.

Oven-ready material for a 100% accurate shape in the result.

À placer directement dans le four pour obtenir une forme précise à 100%.

- + Resistente agli urti, anche nel caso di cadute accidentali.

Impact resistant, even from accidental drops.

Résistance aux chocs, même en cas de chute accidentelle.



- + Mantiene perfettamente la forma nel tempo.

Long-lasting shape.

Garde parfaitement sa forme dans le temps.

MATERIALI INNOVATIVI - INNOVATIVE MATERIALS - MATÉRIAUX INNOVANTS

tritanTM
from eastman



CLARITY



DURABILITY



SAFETY



STYLE



La superiorità di **Tritan**TM rispetto alle altre materie plastiche è stata chiaramente dimostrata e la qualità dei nostri stampi garantisce un ottimo grado di stampaggio ed un'eccellente purezza del materiale.

I prodotti realizzati con **Tritan**TM hanno un'estrema durezza, infatti hanno una resistenza agli urti di gran lunga maggiore rispetto ad altre plastiche e vetro, resistendo straordinariamente agli urti, ai graffi e alle ammaccature, mantenendo queste proprietà anche dopo anni di utilizzo e migliaia di lavaggi in lavastoviglie. **Tritan**TM non contiene BPA, BPS (bisfenolo S) e altri bisfenoli, è questa peculiarità a rendere **Tritan**TM un materiale adatto al contatto con gli alimenti. Gli stampi Chocado sono realizzati con il materiale innovativo **Tritan**TM.



The superiority of **Tritan**TM over other plastics has been clearly demonstrated and the quality of our moulds guarantees an excellent degree of moulding and material purity. Products made with **Tritan**TM have extreme durability, in fact, they have a greater impact resistance than other plastics and glass, impressively resisting to bumps, scratches and dents, retaining these properties even after years of use and thousands of dishwasher washes. **Tritan**TM does not contain BPA, BPS (bisphenol S) or other bisphenols, this fact ensures absolute reliability of these **Tritan**TM products for food contact. Chocado moulds are made with the innovative material **Tritan**TM.



La supériorité de **Tritan**TM sur les autres plastiques a été clairement démontrée et la qualité de nos moules garantit un excellent degré de moulage et une excellente pureté des matériaux. Les produits réalisés avec **Tritan**TM ont une durabilité extrême, en fait, ils ont une résistance aux chocs beaucoup plus grande que les autres plastiques et le verre, ils résistent extrêmement bien aux chocs, aux éraflures et aux bosses, et ils conservent ces propriétés même après des années d'utilisation et des milliers de lavages en lave-vaisselle. **Tritan**TM ne contient pas de BPA, de BPS (bisphénol S) ou d'autres bisphénols, cette caractéristique rend les produits en **Tritan**TM aptes au contact avec les aliments. Les moules Chocado sont réalisés avec le matériau innovant **Tritan**TM.





PAG 13	3D DESIGN CAKES
PAG 27	3D DESIGN DECORATIONS
PAG 31	3D DESIGN SINGLE PORTIONS
PAG 45	3D DESIGN BÛCHES
PAG 55	INSERT MOULDS
PAG 59	TARTE DECOR
PAG 65	VOILÀ COOKIE
PAG 71	NATURAE
PAG 97	CHOCADO
PAG 117	3D CHOCO FIGURES
PAG 125	EASY CHOC
PAG 143	THE NEW TRADITION
PAG 163	AIRPLUS
PAG 169	WINTER HOLIDAY INSPIRATION
PAG 175	CELEBRATION
PAG 181	EASY ICE CREAM
PAG 189	SNACKS & CO.
PAG 195	CAKE DESIGN
PAG 207	ACCESSORIES
PAG 221	SMART IN THE KITCHEN
PAG 234	INDEX

3D DESIGN



3DESIGN

Le due dimensioni non bastano più! Come specialista delle forme, Silikomart non ha potuto resistere a questo nuovo trend e ha sviluppato questa nuova gamma, scatenando una vera rivoluzione della pasticceria!

Two dimensions aren't enough anymore! As shapes specialist, Silikomart couldn't resist to develop and explore this concept, unchaining a real pastry revolution!

Les deux dimensions ne suffisent plus! En tant que spécialiste des formes, Silikomart n'a pas pu résister à cette nouvelle tendance et a développé cette nouvelle gamme, déclenchant une véritable révolution de la pâtisserie!

- Realizzato in silicone Platinum di alta qualità
- Adatto all'uso alimentare
- Risultati da professionista
- Può essere usato fino a -60°C
- Può essere usato fino a +230°C
- Innovativa tecnologia 3D
- Smodellamento perfetto

- *Made in high quality Platinum silicone*
- *Food safe silicone*
- *Professional results*
- *Can be used to -60°C / -76°F*
- *Can be used up to +230°C / +446°F*
- *Innovative 3D technology*
- *Perfect unmoulding*

- *Fabriqué en silicone Platinum de haute qualité*
- *Adapté à un usage alimentaire*
- *Résultats professionnels*
- *Peut être utilisé jusqu'à -60°C.*
- *Peut être utilisé jusqu'à +230°C.*
- *Technologie 3D innovante*
- *Démoulage parfait*



Effetto 3D
3D effect
3D effet

3D DESIGN | CAKES



MAGGIE**NEW**

Item: 20.468.13.0065
 Size: Ø 200 h 52 mm
 Volume: 1400 ml
 Pcs/Master: 4
 EAN: 8051085379729



Effetto 3D
 3D effect
 3D effet

**FAIRYTALE****NEW**

Item: 20.474.13.0065
 Size: Ø 180 h 65 mm
 Volume: 1400 ml
 Pcs/Master: 6
 EAN: 8051085379767



Effetto 3D
 3D effect
 3D effet



BUNNY⁵⁸⁰

NEW

Item: 25.341.87.0065

Silicone mould Size: 276 x 268 h 31 mm

Volume: 520 ml

Thermoformed mould Size: 242 x 228 h 6 mm

Volume: 158 ml

Pcs/Master: 4

EAN: 8051085371358

Conceived with
Jeffrey Cagnes



Il kit è composto da:
1 Stampo in silicone platinum
1 Stampo termoformato

The kit is composed by:
1 Platinum silicone mould
1 Thermoformed mould

Le kit est composé par:
1 Moule en silicone platinum
1 Moule thermoformé

Stampo termoformato
Thermoformed mould
Moule thermoformé



WAVE

Item: 20.466.13.0065

Size: Ø 195 h 63 mm

Volume: 1400 ml

Pcs/Master: 3

EAN: 8051085373499



Effetto 3D
3D effect
3D effet



LOVE STORY

Item: 20.454.13.0065
 Size: 210 x 173 h 18 mm
 Volume: 412 ml
 Pcs/Master: 3
 EAN: 8051085368693

Il kit è composto da:
 2 Stampi in silicone platinum
 1 Tagliapasta

The kit is composed by:
 2 Platinum silicone moulds
 1 Cutter

Le kit est composé par:
 2 Moules en silicone platinum
 1 Emporte-pièce



x 2 Pcs

Effetto 3D
 3D effect
 3D effet



Tagliapasta doppio uso
 Double use cutter
 Emporte-pièce double usage



ECLISSE

Item: 20.455.13.0065
 Size: Ø 180 h 45 mm
 Volume: 1000 ml
 Pcs/Master: 10
 EAN: 8051085367818



Effetto 3D
 3D effect
 3D effet



HEARTBEAT

Item: 20.465.13.0065
Size: 250 x 220 h 52 mm
Volume: 1250 ml
Pcs/Master: 4
EAN: 8051085373420

Conceived with
Sergey Kulkin



Effetto 3D
3D effect
3D effet



DRESS

Item: 20.450.13.0065
Size: Ø 185 h 47 mm
Volume: 1200 ml
Pcs/Master: 4
EAN: 8032539937535



Effetto 3D
3D effect
3D effet



ENDLESS LOVE

Item: 20.452.13.0065
 Size: Ø 190 h 55 mm
 Volume: 1500 ml
 Pcs/Master: 4
 EAN: 8051085356669



Effetto 3D
 3D effect
 3D effet

**NUVOLA**

Item: 25.441.13.0065
 Size: 220 x 110 h 60 mm
 Volume: 2 x 800 ml Tot.: 1600 ml
 Pcs/Master: 4
 EAN: 8051085346530



PASSIONE

Item: 20.443.13.0065
 Size: Ø 202 h 66 mm
 Volume: 1340 ml
 Pcs/Master: 4
 EAN: 8051085346226



Effetto 3D
 3D effect
 3D effet



GEL 01 XXL

Item: 20.439.13.0065
 Size: 185 x 95 h 58 mm
 Volume: 765 ml
 Pcs/Master: 6
 EAN: 8051085346196



*

* Non mettere in forno
 Do not put in the oven
 Ne pas mettre au four

Effetto 3D
 3D effect
 3D effet



HONORÉ

Item: 20.408.13.0065
 Size: Ø 195 h 70 mm
 Volume: 1600 ml
 Pcs/Master: 3
 EAN: 8051085324101



Effetto 3D
 3D effect
 3D effet



WOOLY

Item: 20.431.13.0065
 Size: Ø 190 h 72 mm
 Volume: 1460 ml
 Pcs/Master: 6
 EAN: 8051085333042



Effetto 3D
 3D effect
 3D effet

COLOR

Item: 20.423.13.0065
 Size: Ø 200 h 50 mm
 Volume: 1460 ml
 Pcs/Master: 6
 EAN: 8051085332946



Effetto 3D
 3D effect
 3D effet

MOMENTS

Item: 72.980.13.0065
 Size: Ø 160 h 60 mm
 Volume: 1000 ml
 Pcs/Master: 6
 EAN: 8051085329182



Effetto 3D
 3D effect
 3D effet

TOWER

Item: 20.421.13.0065
 Size: Ø 120 h 100 mm
 Volume: 1100 ml
 Pcs/Master: 4
 EAN: 8051085330997

Conceived with
Maya Vase

**QUADRO**

Item: 20.417.13.0065
 Size: 210 x 210 h 35 mm
 Volume: 1400 ml
 Pcs/Master: 6
 EAN: 8032539936125

**VINILE**

Item: 20.437.13.0065
 Size: Ø 195 h 50 mm
 Volume: 1400 ml
 Pcs/Master: 10
 EAN: 8051085338696



Effetto 3D
 3D effect
 3D effet

DOT

Item: 20.379.13.0065
 Size: Ø 200 h 60 mm
 Volume: 1500 ml
 Pcs/Master: 6
 EAN: 8051085323357



Effetto 3D
 3D effect
 3D effet

INTRECCIO

Item: 20.384.13.0065
 Size: Ø 210 h 70 mm
 Volume: 1650 ml
 Pcs/Master: 3
 EAN: 8051085312290



Effetto 3D
 3D effect
 3D effet

BATTICUORE

Item: 22.820.13.0065
 Size: 205 x 198 h 63 mm
 Volume: 1500 ml
 Pcs/Master: 4
 EAN: 8051085257737



Effetto 3D
 3D effect
 3D effet

RAGGIO

Item: 20.362.13.0065
 Size: Ø 195 h 68 mm
 Volume: 1530 ml
 Pcs/Master: 4
 EAN: 8051085287277



Effetto 3D
 3D effect
 3D effet

**BOLLE**

Item: 20.381.13.0065
 Size: Ø 220 h 55 mm
 Volume: 1600 ml
 Pcs/Master: 6
 EAN: 8051085304721



Effetto 3D
 3D effect
 3D effet

**GOCCIA**

Item: 20.363.13.0065
 Size: Ø 220 h 70 mm
 Volume: 1650 ml
 Pcs/Master: 3
 EAN: 8051085287635



Effetto 3D
 3D effect
 3D effet



GEMMA

Item: 20.374.13.0065
 Size: Ø 180 h 90 mm
 Volume: 1590 ml
 Pcs/Master: 6
 EAN: 8051085294640



Effetto 3D
 3D effect
 3D effet

IO & TE

Item: 25.391.13.0065
 Size base mould: Ø 210 h 60 mm
 Size top mould: Ø 210 h 30 mm
 Volume Tot.: 1770 ml
 Pcs/Master: 3
 EAN: 8051085313761



Top mould

Base mould

Effetto 3D
 3D effect
 3D effet

LUNA

Item: 20.361.13.0065
 Size: Ø 220 h 60 mm
 Volume: 1670 ml
 Pcs/Master: 4
 EAN: 8051085287444



Effetto 3D
 3D effect
 3D effet

BACIO

Item: 20.365.13.0065
 Size: 250 x 150 h 65 mm
 Volume: 1200 ml
 Pcs/Master: 6
 EAN: 8051085285198



Effetto 3D
 3D effect
 3D effet

**GIOIA**

Item: 20.383.13.0065
 Size: Ø 210 h 70 mm
 Volume: 1660 ml
 Pcs/Master: 3
 EAN: 8051085312337



Effetto 3D
 3D effect
 3D effet

**ABBRACCIO**

Item: 28.337.13.0065
 Size: Ø 220 h 65 mm
 Volume: 1700 ml
 Pcs/Master: 4
 EAN: 8051085259380



Effetto 3D
 3D effect
 3D effet

**PRIMAVERA**

Item: 28.338.13.0065
 Size: Ø 220 h 50 mm
 Volume: 1500 ml
 Pcs/Master: 6
 EAN: 8051085258239



Effetto 3D
 3D effect
 3D effet



ELEGANZA

Item: 28.339.13.0065
 Size: Ø 220 h 60 mm
 Volume: 1700 ml
 Pcs/Master: 4
 EAN: 8051085257706

**GIROTONDO**

Item: 28.340.13.0065
 Size: Ø 220 h 57 mm
 Volume: 1700 ml
 Pcs/Master: 4
 EAN: 8051085259403

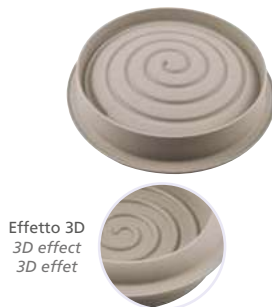
**PERLA 20**

Item: 27.200.13.0065
 Size: Ø 200 h 40 mm
 Volume: 1252 ml
 Pcs/Master: 10
 EAN: 8051085287215

**PERLA 24**

Item: 27.240.13.0065
 Size: Ø 240 h 40 mm
 Volume: 1804 ml
 Pcs/Master: 6
 EAN: 8051085287178



3D DESIGN | DECORATIONS





BLISS

NEW

Item: 26.420.13.0065
 Size: Ø 140 h 10 mm
 Volume: 2 x 100 ml Tot.: 200 ml
 Pcs/Master: 10
 EAN: 8051085379804



Effetto 3D
 3D effect
 3D effet

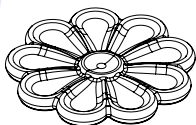

FLOWER POWER

Item: 26.391.13.0065
 Size: Ø 140 h 10 mm
 Volume: 2 x 80 ml Tot.: 160 ml
 Pcs/Master: 10
 EAN: 8051085363896



Effetto 3D
 3D effect
 3D effet

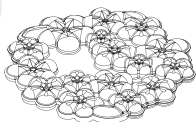

CHABLON BÛCHE

Item: 27.006.13.0065

Size: 96 x 73 - 81 x 69 - 96 x 73 h 2 mm

Volume: 2 x 10 ml + 2 x 12 ml + 2 x 14 ml Tot.: 72 ml

Pcs/Master: 6

EAN: 8051085373604

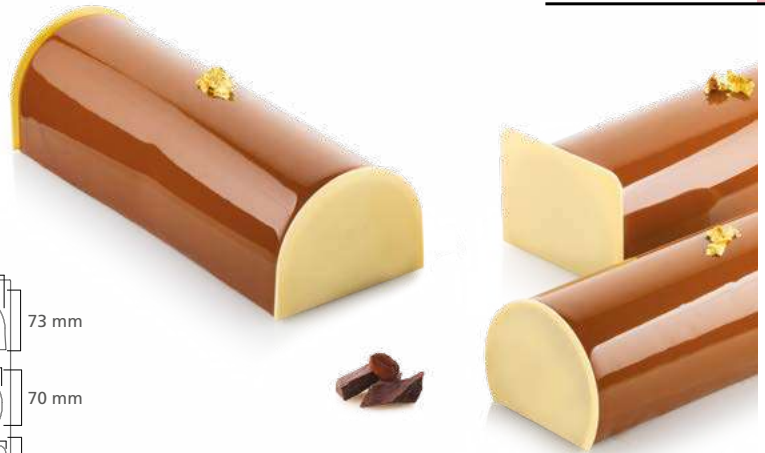
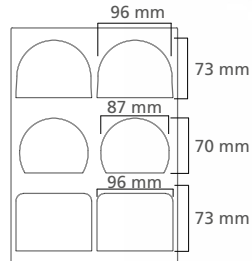
**SNOWBALL**

Item: 23.101.13.0065

Size: Ø 60 h 1.5 mm

Pcs/Master: 6

EAN: 8051085373468

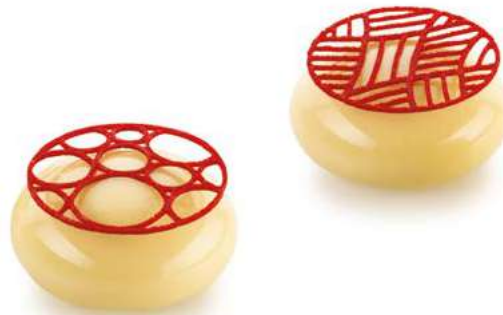
**GARDEN**

Item: 23.089.13.0065

Size: 37 x 60 - 30 x 65 - 43 x 63 h 1.5 mm

Pcs/Master: 6

EAN: 8051085368723



3D DESIGN | SINGLE PORTIONS





EGG HUNT

NEW

Item: 26.421.13.0065

Size: Ø 53 h 67 mm

Volume: 11 x 100 ml Tot.: 1100 ml

Pcs/Master: 8

EAN: 8051085380374



Effetto 3D
3D effect
3D effet



SAPIN MAGIQUE

Item: 26.409.13.0065

Size: Ø 67 h 74 mm

Volume: 6 x 85 ml Tot.: 510 ml

Pcs/Master: 6

EAN: 8051085373383

Conceived with
Enzo Roussel
Christophe Roussel

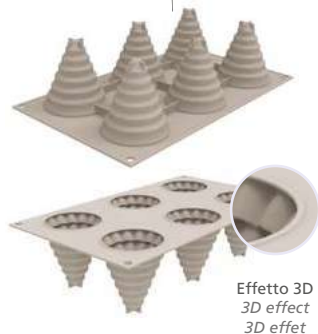

Effetto 3D
3D effect
3D effet



MINI WAVE

Item: 26.406.13.0065
 Size: Ø 73 h 41 mm
 Volume: 6 x 105 ml Tot.: 630 ml
 Pcs/Master: 10
 EAN: 8051085373536

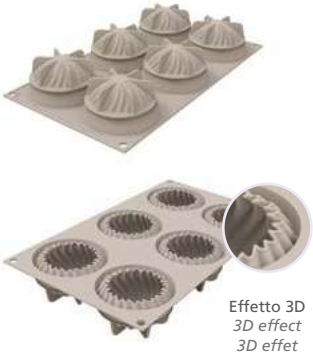

Effetto 3D
 3D effect
 3D effet

**PETAL**

Item: 26.394.13.0065
 Size: 98 x 38 h 48 mm
 Volume: 8 x 94 ml Tot.: 752 ml
 Pcs/Master: 10
 EAN: 8051085363766

Conceived with
Cécile Forkas Moritel

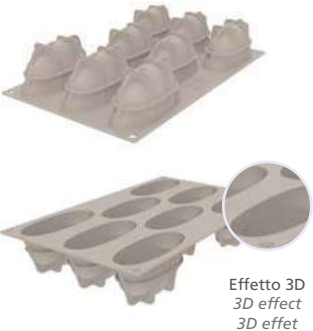

Effetto 3D
 3D effect
 3D effet



MINI LOVE STORY

Item: 26.395.13.0065
 Size: 80 x 66 h 12 mm
 Volume: 8 x 35 ml Tot.: 280 ml
 Pcs/Master: 10
 EAN: 8051085363858

Il kit è composto da:
 1 Stampo in silicone platinum
 1 Tagliapasta

The kit is composed by:
 1 Platinum silicone mould
 1 Cutter

Le kit est composé par:
 1 Moule en silicone platinum
 1 Emporte-pièce



Effetto 3D
 3D effect
 3D effet

Tagliapasta doppio uso
 Double use cutter
 Emporte-pièce double usage

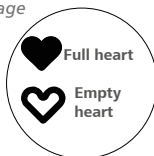
**MINI DRESS**

Item: 26.377.13.0065
 Size: Ø 70 h 30 mm
 Volume: 6 x 96 ml Tot.: 576 ml
 Pcs/Master: 10
 EAN: 8032539937542



Effetto 3D
 3D effect
 3D effet



MINI COLOR

Item: 26.338.13.0065
 Size: Ø 73 h 30 mm
 Volume: 6 x 115 ml Tot.: 690 ml
 Pcs/Master: 10
 EAN: 8051085332991



Effetto 3D
 3D effect
 3D effet

**MINI DOT**

Item: 26.265.13.0065
 Size: Ø 70 h 30 mm
 Volume: 6 x 90 ml Tot.: 540 ml
 Pcs/Master: 10
 EAN: 8051085323319



Effetto 3D
 3D effect
 3D effet

**PUFF**

Item: 26.334.13.0065
 Size: Ø 62 h 52 mm
 Volume: 8 x 125 ml Tot.: 1000 ml
 Pcs/Master: 10
 EAN: 8051085329168



CREAM

Item: 26.343.13.0065

Size: Ø 73 h 65 mm

Volume: 6 x 120 ml Tot.: 720 ml

Pcs/Master: 8

EAN: 8051085346318

Conceived with
Jérôme De Oliveira



Effetto 3D
3D effect
3D effet



MINI PUFF

Item: 26.339.13.0065

Size: Ø 40 h 40 mm

Volume: 14 x 40 ml Tot.: 600ml

Pcs/Master: 10

EAN: 8051085333097



KIT POP ÉCLAIR

Item: 25.275.13.0065
 Base Size: 130 x 38 h 28 mm
 Top Size: 109 x 24 h 12 mm
 Volume Base: 6 x 120 ml Tot.: 720 ml
 Volume Top: 6 x 22 ml Tot.: 132 ml
 Pcs/Master: 10
 EAN: 8051085155552

Base mould



Top mould



Effetto 3D
 3D effect
 3D effet



Utilizzabile come: *usable as: | utilisable comme:*

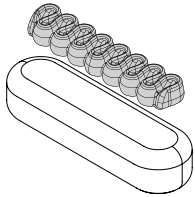

Decorazione
As a decoration
comme une décoration

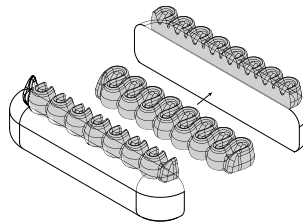

Inserto
As an insert
comme un insert

KIT CHIC ÉCLAIR

Item: 25.284.13.0065
 Base Size: 130 x 38 h 28 mm
 Top Size: 117 x 18 h 16 mm
 Volume Base: 6 x 120 ml Tot.: 720 ml
 Volume Top: 6 x 22 ml Tot.: 132 ml
 Pcs/Master: 10
 EAN: 8051085313846

Base mould



Top mould

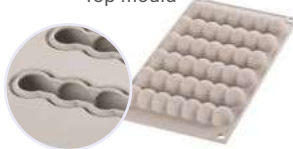

Effetto 3D
 3D effect
 3D effet



Utilizzabile come: *usable as: | utilisable comme:*

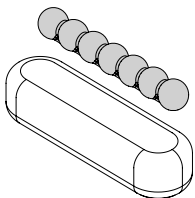

Decorazione
As a decoration
comme une décoration

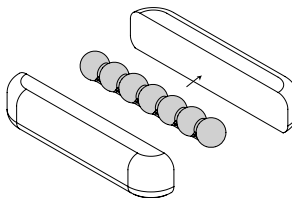

Inserto
As an insert
comme un insert

MINI GEMMA

Item: 26.246.13.0065
 Size: Ø 68 h 42 mm
 Volume: 6 x 110 ml Tot.: 660 ml
 Pcs/Master: 10
 EAN: 8051085293971



Effetto 3D
 3D effect
 3D effet



MINI INTRECCIO

Item: 26.290.13.0065
 Size: Ø 75 h 35 mm
 Volume: 6 x 105 ml Tot.: 630 ml
 Pcs/Master: 10
 EAN: 8051085312603



Effetto 3D
 3D effect
 3D effet



SWING

Item: 26.315.13.0065
 Size: 80 x 45 h 35 mm
 Volume: 6 x 95 ml Tot.: 570 ml
 Pcs/Master: 10
 EAN: 8051085323586



Effetto 3D
 3D effect
 3D effet



COCCOLA

Item: 26.305.13.0065
 Size: Ø 70 h 55 mm
 Volume: 6 x 130 ml Tot.: 780 ml
 Pcs/Master: 10
 EAN: 8051085317431



Effetto 3D
 3D effect
 3D effet

**DOLCE TARTUFO**

Item: 26.192.13.0065
 Size: Ø 62 h 52 mm
 Volume: 8 x 120 ml Tot.: 960 ml
 Pcs/Master: 10
 EAN: 8051085300655



Effetto 3D
 3D effect
 3D effet

**MINI RAGGIO**

Item: 26.233.13.0065
 Size: Ø 67 h 33 mm
 Volume: 6 x 85 ml Tot.: 510 ml
 Pcs/Master: 10
 EAN: 8051085287314

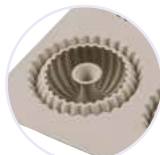

Effetto 3D
 3D effect
 3D effet



MINI GOCCIA

Item: 26.234.13.0065

Size: Ø 68 h 33 mm

Volume: 6 x 88 ml Tot.: 528 ml

Pcs/Master: 10

EAN: 8051085287352



Effetto 3D
3D effect
3D effet



BOLLICINE

Item: 26.270.13.0065

Size: Ø 70 h 30 mm

Volume: 6 x 85 ml Tot.: 510 ml

Pcs/Master: 10

EAN: 8051085304684



Effetto 3D
3D effect
3D effet



SOFFICE INCANTO

Item: 26.271.13.0065

Size: Ø 60 h 70 mm

Volume: 6 x 100 ml Tot.: 600 ml

Pcs/Master: 6

EAN: 8051085304998



Effetto 3D
3D effect
3D effet



MOSAICO

Item: 26.292.13.0065
 Size: 50 x 50 h 50 mm
 Volume: 9 x 105 ml Tot.: 945 ml
 Pcs/Master: 10
 EAN: 8051085314492



Effetto 3D
 3D effect
 3D effet

**MINI GIROTONDO**

Item: 26.211.13.0065
 Size: Ø 68 h 37 mm
 Volume: 6 x 100 ml Tot.: 600 ml
 Pcs/Master: 10
 EAN: 8051085257645



Effetto 3D
 3D effect
 3D effet

**CUORICINO**

Item: 26.186.13.0065
 Size: 65 x 65 h 39 mm
 Volume: 8 x 96 ml Tot.: 768 ml
 Pcs/Master: 10
 EAN: 8051085257676



Effetto 3D
 3D effect
 3D effet



MINI ELEGANZA

Item: 26.212.13.0065

Size: 70 x 70 h 30 mm

Volume: 6 x 100 ml Tot.: 600 ml

Pcs/Master: 10

EAN: 8051085258260



Effetto 3D
3D effect
3D effet



DELIZIA AL LIMONE

Item: 26.261.13.0065

Size: 85 x 59 h 42 mm

Volume: 6 x 106 ml Tot.: 636 ml

Pcs/Master: 10

EAN: 8051085296422



Effetto 3D
3D effect
3D effet



SEGRETI DEL BOSCO

Item: 26.299.13.0065

Size: Ø 65 h 55 mm

Volume: 6 x 115 ml Tot.: 690 ml

Pcs/Master: 10

EAN: 8051085314539



Effetto 3D
3D effect
3D effet



ISPIRAZIONI DI FRUTTA

Item: 26.300.13.0065
 Size: Ø 62 h 52 mm
 Volume: 6 x 118 ml Tot.: 710 ml
 Pcs/Master: 10
 EAN: 8051085314577



Effetto 3D
 3D effect
 3D effet

**FRAGOLE E PANNA**

Item: 26.267.13.0065
 Size: Ø 59 h 61 mm
 Volume: 6 x 95 ml Tot.: 570 ml
 Pcs/Master: 8
 EAN: 8051085155101



Effetto 3D
 3D effect
 3D effet

**ROSSO CILIEGIA**

Item: 26.260.13.0065
 Size: 75 x 50 h 45 mm
 Volume: 6 x 105 ml Tot.: 630 ml
 Pcs/Master: 10
 EAN: 8051085296378



Effetto 3D
 3D effect
 3D effet



3D DESIGN | BÛCHES



BÛCHE COEUR

Item: 20.467.13.0065
 Size: 240 x 90 h 90 mm
 Volume: 1290 ml
 Pcs/Master: 6
 EAN: 8051085374137



Effetto 3D
 3D effect
 3D effet

**BÛCHE SNOWY**

Item: 20.469.13.0065
 Size: 248 x 88 h 80 mm
 Volume: 1400 ml
 Pcs/Master: 6
 EAN: 8051085374182



Effetto 3D
 3D effect
 3D effet



DREAMY

Item: 20.448.13.0065
 Size: 250 x 83 h 78 mm
 Volume: 1200 ml
 Pcs/Master: 6
 EAN: 8032539937498

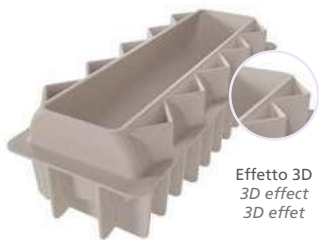

Effetto 3D
 3D effect
 3D effet



BÛCHE LUMIÈRE

Item: 20.451.13.0065
 Size: 219 x 89 h 75 mm
 Volume: 1080 ml
 Pcs/Master: 4
 EAN: 8032539937504

Kit composto da:

Kit composed by:
 Le kit se compose:



Base in plastica

Plastic base
 Base en plastique

* Non mettere in forno
 Do not put in the oven
 Ne pas mettre au four



Do not put
 in the oven



Stampo in silicone platinum per tronchetto

Platinum silicone mould for yule log
 Moule à bûche en silicone platinum

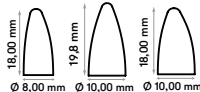

Stampo in silicone platinum per fiammelle

Platinum silicone mould for the flames
 Moule en silicone platinum pour flammes



WINTER VILLAGE

Item: 20.438.13.0065
 Size: 88 x 218 h 80 mm
 Volume: 1200 ml
 Pcs/Master: 4
 EAN: 8032539937450

Kit composto da:

Kit composed by:
 Le kit se compose:

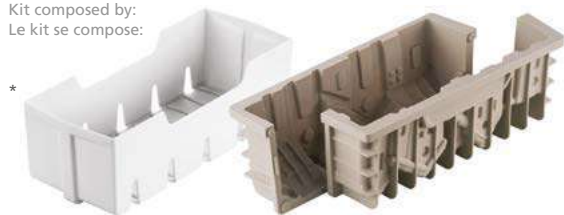

Base in plastica
 Plastic base
 Base en plastique

Stampo in silicone platinum per tronchetto
 Platinum silicone mould for yule log
 Moule à bûche en silicone platinum

* Non mettere in forno
 Do not put in the oven
 Ne pas mettre au four



BÛCHE SAPIN

Item: 20.436.13.0065
 Size: 250 x 89 h 87 mm
 Volume: 1000 ml
 Pcs/Master: 6
 EAN: 8051085338382



Effetto 3D
 3D effect
 3D effet



BÛCHE QUENELLE

Item: 20.434.13.0065
 Size: 243 x 90 h 77 mm
 Volume: 1300 ml
 Pcs/Master: 4
 EAN: 8032539937443



Effetto 3D
 3D effect
 3D effet



LANA

Item: 20.418.13.0065
 Size: 245 x 95 h 77 mm
 Volume: 1200 ml
 Pcs/Master: 4
 EAN: 8032539936095



Effetto 3D
 3D effect
 3D effet



ARTIC

Item: 20.419.13.0065
 Size: 250 x 92 h 87 mm
 Volume: 1000 ml
 Pcs/Master: 6
 EAN: 8032539936101



CORALLO

Item: 20.399.13.0065
 Size: 245 x 90 h 90 mm
 Volume: 1400 ml
 Pcs/Master: 6
 EAN: 8051085317356



Effetto 3D
 3D effect
 3D effet

MERINGA

Item: 20.360.13.0065
 Size: 250 x 90 h 75 mm
 Volume: 1100 ml
 Pcs/Master: 4
 EAN: 8051085287482



Effetto 3D
 3D effect
 3D effet

KIT ICE GLOW

Item: 25.108.99.0065
 Size: 260 x 100 h 75 mm
 Volume: 910 ml
 Pcs/Master: 4
 EAN: 8051085317318



Effetto 3D
 3D effect
 3D effet

MAYA BÛCHE

Item: 25.077.63.0065
 Size Silicone Mat: 250 x 80 h 67 mm
 Volume Bûche: 1200 ml
 Pcs/Master: 6
 EAN: 805108573345

Kit composto da:

Kit composed by:
 Le kit se compose:

1 Bûche in plastica
 1 Plastic Bûche
 1 Bûche en plastique

Base in plastica
 Non mettere in forno



Plastic base
 Do not put in the oven

Base en plastique
 Ne pas mettre au four



2 Testatine in silicone platinum
 2 Platinum silicone headers
 2 Têtes en silicone platinum



2 Tappetini in silicone platinum
 2 Platinum silicone mats
 2 Tapis en silicone platinum

DIAMOND BÛCHE

Item: 25.074.63.0065
 Size: 250 x 90 h 75 mm
 Volume: 1200 ml
 Pcs/Master: 4
 EAN: 8051085287482

1 Bûche in plastica
 1 Plastic Bûche
 1 Bûche en plastique

Base in plastica
 Non mettere in forno
 Plastic base
 Do not put in the oven
 Base en plastique
 Ne pas mettre au four



Kit composto da:

Kit composed by:
 Le kit se compose:



2 Testatine in silicone platinum
 2 Platinum silicone headers
 2 Têtes en silicone platinum

2 Tappetini in silicone platinum
 2 Platinum silicone mats
 2 Tapis en silicone platinum



STARLIGHT BÛCHE

Item: 25.075.63.0065
 Size: 250 x 80 h 67 mm
 Volume: 1200 ml
 Pcs/Master: 6
 EAN: 8051085155538

1 Bûche in plastica
 1 Plastic Bûche
 1 Bûche en plastique

Base in plastica
 Non mettere in forno
 Plastic base
 Do not put in the oven
 Base en plastique
 Ne pas mettre au four



Kit composto da:
 Kit composed by:
 Le kit se compose:



2 Testatine in silicone platinum
 2 Platinum silicone headers
 2 Têtes en silicone platinum

2 Tappetini in silicone platinum
 2 Platinum silicone mats
 2 Tapis en silicone platinum

**FROZEN BÛCHE**

Item: 25.071.63.0065
 Size: 250 x 80 h 67 mm
 Volume: 1200 ml
 Pcs/Master: 6
 EAN: 8051085260058

1 Bûche in plastica
 1 Plastic Bûche
 1 Bûche en plastique

Base in plastica
 Non mettere in forno
 Plastic base
 Do not put in the oven
 Base en plastique
 Ne pas mettre au four



Kit composto da:
 Kit composed by:
 Le kit se compose:



2 Testatine in silicone platinum
 2 Platinum silicone headers
 2 Têtes en silicone platinum

2 Tappetini in silicone platinum
 2 Platinum silicone mats
 2 Tapis en silicone platinum

**MAGIC BÛCHE**

Item: 25.059.63.0065
 Size: 250 x 80 h 67 mm
 Volume: 1200 ml
 Master: 6
 EAN: 8051085260034

1 Bûche in plastica
 1 Plastic Bûche
 1 Bûche en plastique

Base in plastica
 Non mettere in forno
 Plastic base
 Do not put in the oven
 Base en plastique
 Ne pas mettre au four



Kit composto da:
 Kit composed by:
 Le kit se compose:



2 Testatine in silicone platinum
 2 Platinum silicone headers
 2 Têtes en silicone platinum

2 Tappetini in silicone platinum
 2 Platinum silicone mats
 2 Tapis en silicone platinum



KIT MAGIC WOOD

Item: 25.057.99.0065
 Size: 296 x 130 h 72 mm
 Volume: 1300 ml
 Pcs/Master: 6
 EAN: 8051085321308

Kit composto da:
Kit composed by:
Le kit se compose:



Stampo in silicone platinum per tronchetto
 Platinum silicone mould for yule log
 Moule à bûche en silicone platinum

1 Tappetino in silicone platinum
 1 Platinum silicone mat
 1 Tapis en silicone platinum



KIT MAGIC LOVE

Item: 25.072.99.0063
 Size: 296 x 130 h 72 mm
 Volume: 1300 ml
 Pcs/Master: 6
 EAN: 8051085261482

Kit composto da:
Kit composed by:
Le kit se compose:



Stampo in silicone platinum per tronchetto
 Platinum silicone mould for yule log
 Moule à bûche en silicone platinum

1 Tappetino in silicone platinum
 1 Platinum silicone mat
 1 Tapis en silicone platinum



MAGIC BÛCHE MAT

Item: 23.059.63.0065
 Size: 250 x 185 h 6 mm
 Pcs/Master: 6
 EAN: 8051085278114

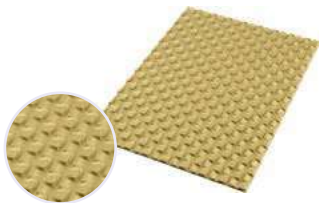

FROZEN BÛCHE MAT

Item: 23.071.63.0065
 Size: 250 x 185 h 6 mm
 Pcs/Master: 6
 EAN: 8051085278091

**MAGIC WOOD MAT**

Item: 23.057.77.0065
 Size: 250 x 185 h 6 mm
 Pcs/Master: 6
 EAN: 8051085278077

**MAGIC LOVE MAT**

Item: 23.072.77.0065
 Size: 250 x 185 h 6 mm
 Pcs/Master: 6
 EAN: 8051085278053



INSERT MOULDS



INSERT PROJECT

Silikomart, come specialista delle forme, ha abbracciato la necessità di creare dessert stratificati caratterizzati da gusti e texture diversi per creare torte ed entremets come quelli dei professionisti.

As the shapes specialist, Silikomart embraced the need to create multiple layers of different tastes and textures in order to create professional-like cakes and entremets.

Silikomart, en tant que spécialiste des formes, a compris la nécessité de créer des desserts caractérisés par des goûts et des textures différents pour créer des gâteaux et des entremets comme ceux des professionnels.



MULTI-INSERTO ROUND

Item: 20.405.13.0065

Size small insert: Ø 30 h 25 mm

Size savarin insert: Ø 150 h 25 mm

Size big insert: Ø 176 h 25 mm

Volume small insert: 18 ml

Volume savarin insert: 300 ml

Volume big insert: 600 ml

Pcs/Master: 10

EAN: 8051085318308



Lato A - Side A - Face A

Lato B - Side B - Face B

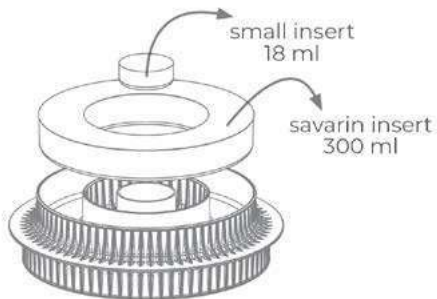

+

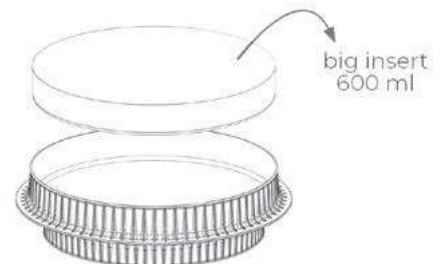

INSERTO BÛCHE & CAKE

Item: 20.404.13.0065

Small insert: 200 x 35 h 30 mm

Big insert: 220 x 50 h 40 mm

Volume Small insert: 190 ml

Volume big insert: 400 ml

Pcs/Master: 6

EAN: 8051085318261



Lato A - Side A - Face A



Lato B - Side B - Face B



 Capovolgli lo stampo
 Flip the mould
 Tourner le moule

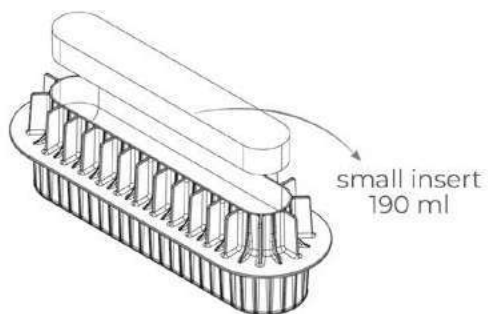

+

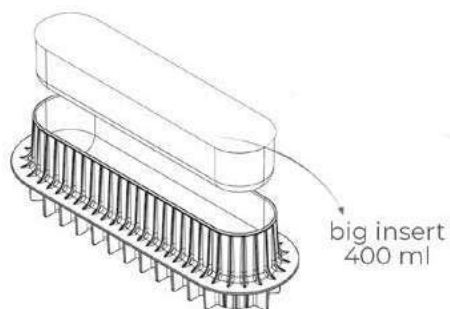

TARTE DECOR



TarteDecor

Il nuovo progetto TARTE DECOR rinnova il concetto di crostate attraverso materiali e design innovativi, il giusto mix di innovazione e tradizione per ottenere facilmente una crostata perfetta come quella di un pasticciere.

The new TARTE DECOR project renews the concept of tarts through innovative materials and designs, the right mix of innovation and tradition to easily obtain a perfect tart worthy of a pastry chef.

Découvrez le nouveau projet TARTE DECOR, le mélange parfait d'innovation et de tradition pour obtenir facilement une tarte parfaite comme celle d'un chef pâtissier.

ANELLO IN TPLUS+ • TPLUS+ RING • CERCLE À TARTE EN TPLUS+

- Facile da smodellare
- Cottura omogenea indeformabile
- Antiaderente
- Non deve essere imburato
- Lavabile in lavastoviglie
- Elevata stabilità termica
- Si può usare come coppapasta
- Easy and perfect unmoulding
- Homogeneous baking
- Undeformable
- Stainless
- Non-stick
- It should not be greased
- Dishwasher safe
- High thermal stability
- Can be used as a cutter
- Démoulage facile
- Cuisson homogène
- Indéformable
- Antiadhésif
- Il ne doit pas être beurré
- Il passe au lave-vaisselle
- Stabilité thermique élevée
- Utilisé comme emporte pièce



Modo d'uso: How to use: | Mode d'emploi:



TARTE RING CLASSIC

Item: 52.368.20.1065
 Size: Ø 160 h 35 mm
 Pcs/Master: 10
 EAN: 8051085346653



Anello Microforato in Tplus+
 Tplus+ microperforated ring
 Cercle à tarte perforé en Tplus+



KIT TARTE GRAFIQUE

Item: 23.202.13.0065
 Size mould: Ø 230 h 20 mm
 Size ring: Ø 250 h 20 mm
 Volume Silicone Mould: 710 ml
 Pcs/Master: 6
 EAN: 8051085312474

Il kit è composto da:
 1 Anello microforato in Tplus+ Ø 250 h 20 mm
 1 Stampo in silicone platinum

The kit is composed by:
 1 Tplus+ microperforated ring Ø 250 h 20 mm
 1 Decorative platinum silicone mould

Le kit est composé par:
 1 Cercle à tarte perforé en Tplus+ Ø 250 h 20 mm
 1 Moule décoratif en silicone platinum



Effetto 3D
 3D effect
 3D effet

Anello Microforato in Tplus+
 Tplus+ microperforated ring
 Cercle à tarte perforé en Tplus+



KIT TARTE LIBERTY

Item: 20.398.13.0065
 Size mould: 180 x 180 h 20 mm
 Size ring: 200 x 200 h 20 mm
 Volume Silicone Mould: 560 ml
 Pcs/Master: 6
 EAN: 8051085317592

Il kit è composto da:
 1 Anello microforato in Tplus+ 200 x 200 h 20 mm
 1 Stampo in silicone platinum

The kit is composed by:
 1 Tplus+ microperforated ring 200 x 190 h 20 mm
 1 Decorative platinum silicone mould

Le kit est composé par:
 1 Cercle à tarte perforé en Tplus+ 200 x 190 h 20 mm
 1 Moule décoratif en silicone platinum



Effetto 3D
 3D effect
 3D effet

Anello Microforato in Tplus+
 Tplus+ microperforated ring
 Cercle à tarte perforé en Tplus+



KIT TARTE MERINGUÉ

Item: 23.201.13.0065

Size mould: Ø 230 h 18 mm

Size ring: Ø 250 h 20 mm

Volume Silicone Mould: 480 ml

Pcs/Master: 6

EAN: 8032539935777

Il kit è composto da:

1 Anello microforato in Tplus+ Ø 250 h 20 mm
1 Stampo in silicone platinum*The kit is composed by:*1 Tplus+ microperforated ring Ø 250 h 20 mm
1 Decorative platinum silicone mould*Le kit est composé par:*1 Cercle à tarte perforé en Tplus+ Ø 250 h 20 mm
1 Moule décoratif en silicone platinumEffetto 3D
3D effect
3D effetAnello Microforato in Tplus+
Tplus+ microperforated ring
Cercle à tarte perforé en Tplus+**KIT TARTE MON AMOUR**

Item: 20.407.13.0065

Size mould: 188 x 158 h 26 mm

Size ring: 200 x 190 h 20 mm

Volume Silicone Mould: 460 ml

Pcs/Master: 12

EAN: 8051085323548

Il kit è composto da:

1 Anello microforato in Tplus+ 200 x 190 h 20 mm
1 Stampo in silicone platinum*The kit is composed by:*1 Tplus+ microperforated ring 200 x 190 h 20 mm
1 Decorative platinum silicone mould*Le kit est composé par:*1 Cercle à tarte perforé en Tplus+ 200 x 190 h 20 mm
1 Moule décoratif en silicone platinumEffetto 3D
3D effect
3D effetAnello Microforato in Tplus+
Tplus+ microperforated ring
Cercle à tarte perforé en Tplus+**KIT MINI TARTE PETIT AMOUR**

Item: 25.317.13.0065

Size mould: 66 x 55 h 15 mm

Size ring: 78 x 68 h 20 mm

Volume Silicone Mould: 8 x 31 ml Tot.: 248 ml

Pcs/Master: 10

EAN: 8051085323500

Il kit è composto da:

8 Anelli microforati in Tplus+ 78 x 68 h 20 mm
1 Stampo in silicone platinum*The kit is composed by:*8 Tplus+ microperforated rings 78 x 68 h 20 mm
1 Decorative platinum silicone mould*Le kit est composé par:*8 Cercles à tarte perforé en Tplus+ 78 x 68 h 20 mm
1 Moule décoratif en silicone platinumEffetto 3D
3D effect
3D effet

x8 Pcs

Anello Microforato in Tplus+
Tplus+ microperforated ring
Cercle à tarte perforé en Tplus+

KIT TARTE NOUVELLE VAGUE

Item: 23.107.13.0065

Size mould: 240 x 80 h 24 mm

Size ring: 265 x 105 h 20 mm

Volume Silicone Mould: 290 ml

Pcs/Master: 6

EAN: 8051085313952

Il kit è composto da:

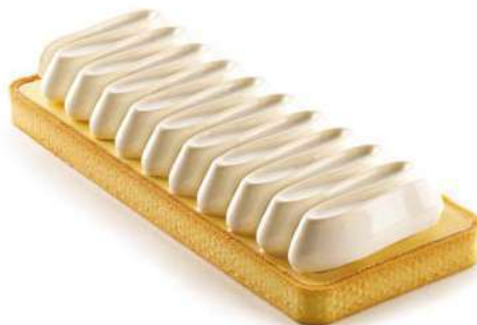
1 Anello microforato in Tplus+ 265 x 105 h 20 mm
1 Stampo in silicone platinum*The kit is composed by:**1 Tplus+ microperforated ring 265 x 105 h 20 mm
1 Decorative platinum silicone mould**Le kit est composé par:**1 Cercle à tarte perforé en Tplus+ 265 x 105 h 20 mm
1 Moule décoratif en silicone platinum***KIT TARTE BAMBOO**

Item: 23.109.13.0065

Size mould: 250 x 90 h 20 mm

Size ring: 265 x 105 h 20 mm

Volume Silicone Mould: 380 ml

Pcs/Master: 6

EAN: 8051085318223

Il kit è composto da:

1 Anello microforato in Tplus+ 265 x 105 h 20 mm
1 Stampo in silicone platinum*The kit is composed by:**1 Tplus+ microperforated ring 265 x 105 h 20 mm
1 Decorative platinum silicone mould**Le kit est composé par:**1 Cercle à tarte perforé en Tplus+ 265 x 105 h 20 mm
1 Moule décoratif en silicone platinum*

KIT MINI TARTE TWIST

Item: 25.273.13.0065

Size mould: Ø 70 h 25 mm

Size ring: Ø 80 h 20 mm

Volume Silicone Mould: 318 ml

Pcs/Master: 10

EAN: 8032539935784

Il kit è composto da:

6 Anelli microforati in Tplus+ Ø 80 h 20 mm
1 Stampo in silicone platinum

The kit is composed by:

6 Tplus+ microperforated rings Ø 80 h 20 mm
1 Decorative platinum silicone mould

Le kit est composé par:

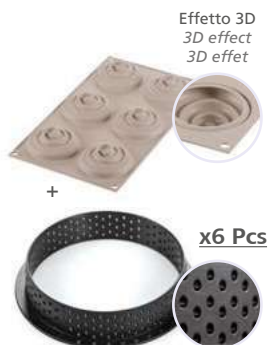
6 Cercles à tarte perforé en Tplus+ Ø 80 h 20 mm
1 Moule décoratif en silicone platinumEffetto 3D
3D effect
3D effet**x6 Pcs**Anello Microforato in Tplus+
Tplus+ microperforated ring
Cercle à tarte perforé en Tplus+**KIT MINI TARTE SAND**

Item: 25.304.13.0065

Size mould: 67 x 67 h 15 mm

Size ring: 80 x 80 h 20 mm

Volume Silicone Mould: 270 ml

Pcs/Master: 11

EAN: 8051085317394

Il kit è composto da:

6 Anelli microforati in Tplus+ 80 x 80 h 20 mm
1 Stampo in silicone platinum

The kit is composed by:

6 Tplus+ microperforated rings 80 x 80 h 20 mm
1 Decorative platinum silicone mould

Le kit est composé par:

6 Cercles à tarte perforé en Tplus+ 80 x 80 h 20 mm
1 Moule décoratif en silicone platinumEffetto 3D
3D effect
3D effet**x6 Pcs**Anello Microforato in Tplus+
Tplus+ microperforated ring
Cercle à tarte perforé en Tplus+**KIT MINI TARTE GLAM**

Item: 25.293.13.0065

Size mould: Ø 70 h 18 mm

Size ring: Ø 80 h 20 mm

Volume Silicone Mould: 276 ml

Pcs/Master: 10

EAN: 8051085312566

Il kit è composto da:

6 Anelli microforati in Tplus+ Ø 80 h 20 mm
1 Stampo in silicone platinum

The kit is composed by:

6 Tplus+ microperforated rings Ø 80 h 20 mm
1 Decorative platinum silicone mould

Le kit est composé par:

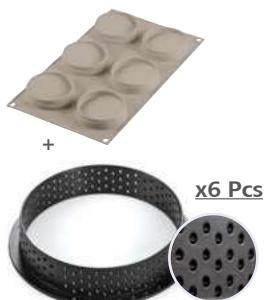
6 Cercles à tarte perforé en Tplus+ Ø 80 h 20 mm
1 Moule décoratif en silicone platinum**x6 Pcs**Anello Microforato in Tplus+
Tplus+ microperforated ring
Cercle à tarte perforé en Tplus+

VOILÀ COOKIE



VOILÀ COOKIE

Prepara in 5 secondi i tuoi biscotti dolci e salati dalla forma perfetta.

Prepare in 5 seconds your perfectly shaped sweet and savory cookies.

Préparez en 5 secondes vos cookies sucrés et salés avec une forme parfaite.

T PLUS+

- Speciale materiale fornabile
- I biscotti non si muovono nè si attaccano durante la cottura
- Taglio netto e perfetto con ogni impasto
- Facile da pulire
- Tutto l'impasto viene utilizzato senza sprechi
- Salva-tempo, prepara i tuoi biscotti in 5 secondi

- *Oven-ready special material*
- *The cookies don't move or stick during the baking*
- *Perfect and neat cut with every dough*
- *Easy to clean*
- *All the dough is used without any waste*
- *Time saving, prepare your cookies in 5 seconds*

- *Matériau spécial adapté au four*
- *Les cookies ne bougent ni se collent pas pendant la cuisson*
- *Coupe nette et parfaite avec chaque appareil*
- *Facile à nettoyer*
- *Toute la pâte est utilisée sans gaspillage*
- *Rapide, préparez vos cookies en 5 secondes*

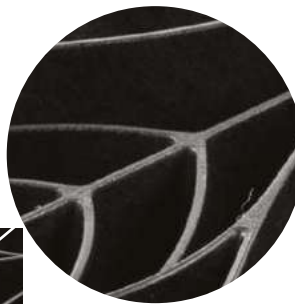
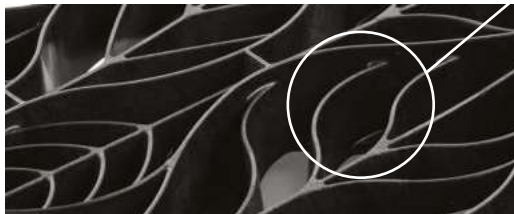

1

Premere VOILÀ COOKIE sull'impasto.
Press VOILÀ COOKIE over the dough.
Presser VOILÀ COOKIE sur la pâte



2

Mettere VOILÀ COOKIE in forno
Put VOILÀ COOKIE in the oven and bake
Enfourner VOILÀ COOKIE tout ensemble



3

Sfornare e togliere VOILÀ COOKIE
Take it out from the oven and remove VOILÀ COOKIE
Sortir du four et enlever VOILÀ COOKIE



VOILÀ COOKIE - LEAVES

Item: 53.151.20.0065

Size: 240 x 150 h 20 mm

Pcs/Master: 10

EAN: 8051085334445



VOILÀ COOKIE - WINTER HOLIDAY

Item: 53.152.20.0065

Size: 240 x 150 h 20 mm

Pcs/Master: 10

EAN: 8051085340095



VOILÀ COOKIE LOVE

Item: 53.153.20.0065

Size mould: 240 x 150 h 20 mm

Pcs/Master: 10

EAN: 8032539937481

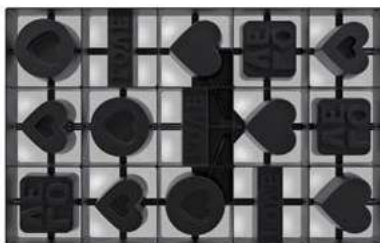

ALTA RISTORAZIONE / HAUTE CUISINE

Naturae[®]





La natura come non l'avete mai vista.

Un'originale interpretazione degli elementi naturali per dare forma ad un'inedita versione del gusto.

Dal laboratorio di innovazione di Silikomart nasce la nuova gamma Naturae, sviluppata grazie alla visione creativa e avanguardista di alcuni degli chef più acclamati del panorama nazionale e internazionale.

Naturae ti farà sentire un vero chef portando nella tua cucina tutti i plus che caratterizzano il silicone platinum di Silikomart, dall'alta performance, alla resistenza termica (-60°C +230°C) e all'estrema flessibilità. Inoltre, gli stampi Silikomart sono garantiti per 3000 cotture, permettendoti di sperimentare a lungo.

Una linea di stampi in silicone platinum dedicata interamente alla natura, perfetta per cimentarti in piatti esclusivi come antipasti, entrée e portate principali.

The nature as you have never seen it.

An original interpretation of the elements of nature to shape an innovative version of taste.

From Silikomart's innovation laboratory comes the new Naturae range, developed thanks to the creative and avant-garde vision of some of the most acclaimed chefs on the national and international scene.

Naturae will make you feel like a real chef by bringing all the pluses that characterise Silikomart's platinum silicone into your kitchen, from high performance to thermal resistance (-60°C/-76°F +230°C/446°F) and extreme flexibility. In addition, Silikomart moulds are guaranteed for 3000 baking cycles, allowing you to experiment for a long time.

A line of platinum silicone moulds dedicated entirely to nature, perfect for testing exclusive dishes such as starters, entrées and main courses.

La nature comme vous ne l'avez jamais vue.

Une interprétation originale des éléments naturels pour façonner une version inédite du goût.

Le laboratoire d'innovation de Silikomart a donné naissance à la nouvelle gamme Naturae, développée grâce à la vision créative et avant-gardiste de certains des chefs les plus renommés sur la scène nationale et internationale.

Naturae vous fera sentir comme un véritable chef en apportant dans votre cuisine tous les avantages qui caractérisent le silicone platinum de Silikomart, de la haute performance à la résistance thermique (-60°C +230°C) en passant par l'extrême flexibilité. De plus, les moules Silikomart sont garantis pour 3000 utilisations, ce qui vous permettra d'expérimenter presque à l'infini.

Une ligne de moules en silicone platinum entièrement dédiée à la nature, idéale pour s'essayer à des plats exclusifs tels que les hors-d'œuvre, les entrées ou les plats principaux.

THE DECORS
I DECORI



BOTANICA

Item: 33.316.36.0065

Size Big: Ø 84 h 2 mm

Size Small: Ø 46 h 2 mm

Pcs/Master: 10

EAN: 8051085366019



Plated dessert
Dessert al piatto



MELA & PERA

Item: 33.317.36.0065

Size: 80 x 56 h 1.5 mm -

60 x 51 h 2 mm

Pcs/Master: 10

EAN: 8051085366057



Plated dessert
Dessert al piatto



PIATTO⁸⁰

Item: 33.315.36.0065
 Size: Ø 115 h 15 mm
 Volume: 83 ml
 Pcs/Master: 10
 EAN: 8051085358755



CORONA

Item: 33.311.36.0065
 Size: Ø 68 - Ø 77 h 2 mm
 Pcs/Master: 10
 EAN: 8051085357765



Conceived with
 Jimmi Eriksson

Jimmi Eriksson



Plated dessert
 Dessert al piatto

EDEN

Item: 33.312.36.0065
 Size: 73 x 33 –
 73 x 47 h 2 mm
 Pcs/Master: 10
 EAN: 8051085357727



Conceived with
 Jimmi Eriksson

Jimmi Eriksson

Plated dessert
 Dessert al piatto



LAMPO

Item: 33.313.36.0065
 Size: 131 x 26 h 2 mm
 Pcs/Master: 10
 EAN: 8051085358830

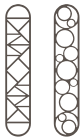

Conceived with
 Jimmi Eriksson

Jimmi Eriksson

Plated dessert
 Dessert al piatto



PIUMA

Item: 33.314.36.0065
 Size: 121 x 28 –
 79 x 23 h 2 mm
 Pcs/Master: 10
 EAN: 8051085357802



Conceived with
 Alessandro Bergamo

Plated dessert
 Dessert al piatto



BOSCO

Item: 33.301.36.0065
 Size: 60 x 37 –
 71 x 69 h 2 mm
 Pcs/Master: 10
 EAN: 8051085327454



FORESTA

Item: 33.302.36.0065
Size: 66 x 30 -
62 x 43 h 2 mm
Pcs/Master: 10
EAN: 8051085327478

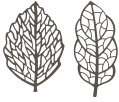

THE GARDEN
L'ORTO



BACCELLO¹³

Item: 36.398.36.0065
Size: 110 x 35 h 12 mm
Volume: 13 ml
Pcs/Master: 10
EAN: 8051085366873



CARCIOFO²⁸

Item: 36.400.36.0065
Size: 41 x 62 h 28 mm
Volume: 28 ml
Pcs/Master: 10
EAN: 8051085365418

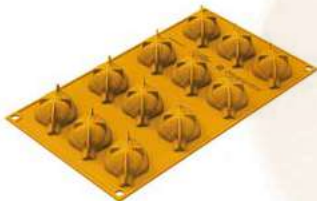

VERZA¹²

Item: 33.318.36.0065
 Size: Ø 70 h 5 mm
 Volume: 12 ml
 Pcs/Master: 7
 EAN: 8051085366095



AGLIO⁴

Item: 36.366.36.0065
 Size: 33 x 19 h 19 mm
 Volume: 4 ml
 Pcs/Master: 10
 EAN: 8051085357666



Conceived with
 Alessandro Bergamo

POMODORINO¹⁴

Item: 36.376.36.0065

Size: Ø 31 h 25 mm

Volume: 14 ml

Pcs/Master: 10

EAN: 8051085357499



LIMONE¹⁴

Item: 36.371.36.0065

Size: 65 x 35 h 14 mm

Volume: 14 ml

Pcs/Master: 10

EAN: 8051085357536



PANNOCCIA²⁰

Item: 36.327.36.0065
 Size: 68 x 26 h 21 mm
 Volume: 20 ml
 Pcs/Master: 10
 EAN: 8051085327355



Conceived with
 Terry Giacomello



PEPERONCINO¹³

Item: 36.329.36.0065
 Size: 91 x 31 h 16 mm
 Volume: 13 ml
 Pcs/Master: 10
 EAN: 8051085327379



POMODORO²⁴

Item: 36.330.36.0065

Size: Ø 43 h 28 mm

Volume: 24 ml

Pcs/Master: 10

EAN: 8051085327287



CAROTA²⁰

Item: 36.328.36.0065

Size: 78 x 23 h 23 mm

Volume: 20 ml

Pcs/Master: 10

EAN: 8051085327362



Conceived with
Viviana Varese

frühe prese

THE LAND

LA TERRA



PORCINO

Item: 36.401.36.0065
Size: 36 x 59 h 18 mm -
46 x 53 h 22 mm
Volume: 13 - 20 ml
Pcs/Master: 10
EAN: 8051085365364

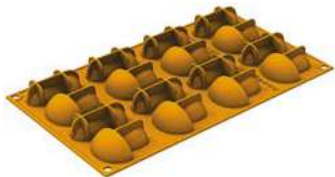

TORTELLINO²⁰

Item: 36.367.36.0065
Size: Ø 54 h 22 mm
Volume: 20 ml
Pcs/Master: 10
EAN: 8051085327362



MICHETTA⁹²

Item: 36.356.36.0065
 Size: Ø 64 h 45 mm
 Volume Top: 45 ml
 Volume Base: 48 ml
 Pcs/Master: 10
 EAN: 8051085337491



Conceived with
 Cristina Bowerman

Cristina Bowerman



FEMORE³²

Item: 36.350.36.0065
 Size: 31 x 90 h 26 mm
 Volume: 32 ml
 Pcs/Master: 10
 EAN: 8051085338535



MILANESE²⁵

Item: 36.348.36.0065
Size: 50/45/51 x 52/57/52
h 18,5 mm
Volume: 25 ml
Pcs/Master: 10
EAN: 8051085338283



ERBETTA⁴³

Item: 33.310.36.0065
Size: Ø 100 h 8 mm
Volume: 43 ml
Pcs/Master: 7
EAN: 8051085337620



THE SEA

IL MARE



CANESTRELLO¹⁵

Item: 36.399.36.0065

Size: 72 x 65 h 8 mm

Volume: 15 ml

Pcs/Master: 10

EAN: 8051085365456



POLPO²⁰

Item: 36.357.36.0065

Size: 60 x 55 h 20 mm

Volume: 20 ml

Pcs/Master: 10

EAN: 8051085338320



SCAMPO²⁰

Item: 36.349.36.0065
 Size: 81x 42 h 14 mm
 Volume: 20 ml
 Pcs/Master: 10
 EAN: 8051085338184



LISCA⁴

Item: 33.309.36.0065
 Size: 104 x 35 h 4 mm
 Volume: 4 ml
 Pcs/Master: 7
 EAN: 8051085338467



THE GEOMETRY

LA GEOMETRIA



CERCHIO 3.0

Item: 33.303.36.0065
 Size: Ø 22 -58 - 100
 h 5,5 mm
 Volume: 2 - 11 - 25 ml
 Pcs/Master: 7
 EAN: 8051085327485



CERCHIO 4.0

Item: 33.304.36.0065
 Size: Ø 100 h 5,5 mm
 Volume: 40 ml
 Pcs/Master: 7
 EAN: 8051085327492



QUADRATO 3.0

Item: 33.305.36.0065
Size: 20 x 20 - 56 x 56
98 x 98 h 5,5 mm
Volume: 2- 12 - 30
Pcs/Master: 7
EAN: 8051085327508



QUADRATO 4.0

Item: 33.306.36.0065
Size: 48,5 x 48,5 h 5,5 mm
Volume: 12,5 ml
Pcs/Master: 7
EAN: 8051085327515



TRIANGOLO 2.0

Item: 33.308.36.0065
 Size: 110,5 x 97 -
 42,41 x 37,6 h 5,5 mm
 Volume: 25 - 5 ml
 Pcs/Master: 7
 EAN: 8051085327539



TRIANGOLO 3.0

Item: 33.307.36.0065
 Size: 103 x 95 h 5,5 mm
 Volume: 10,5 ml
 Pcs/Master: 7
 EAN: 8051085327522





CHOCADO

LA GAMMA CHOCADO

THE CHOCADO RANGE | LA GAMME CHOCADO

Dal laboratorio di innovazione di Silikomart nasce Chocado: la nuova gamma di forme progettate da cioccolatieri per i cioccolatieri e non solo. Silikomart approda nel settore dell'alta cioccolateria portando con sé tutti i plus che caratterizzano il nuovo materiale Tritan™ e il silicone liquido platinico. Dall'alta performance, alla resistenza termica e all'estrema durevolezza.

From the innovative laboratory of Silikomart comes Chocado: the new range of shapes designed by chocolatiers for chocolatiers and amateurs. Silikomart lands in the haute chocolatier sector bringing with it all the advantages that characterized the new Tritan™ material and the platinum liquid silicone. From high performance, to thermal resistance and extreme durability.

Du laboratoire d'innovation de Silikomart naît Chocado : la nouvelle gamme des formes conçues par les chocolatiers pour les chocolatiers et pour les amateurs. Silikomart débarque dans le secteur de la haute chocolaterie en apportant tous les avantages qui caractérisent le nouveau matériel Tritan™ et le silicone liquide platinique. De la haute performance à la résistance thermique et à l'extrême durabilité.





REALIZZA PRALINE CON INSERTI PERFETTI.
CREATE CHOCOLATES WITH PERFECT INSERTS.
PRALINES AVEC UN INSERT PARFAIT.

Libera la tua creatività e realizza cioccolatini unendo il gusto del cioccolato a diversi sapori e consistenze.

Unleash your creativity and create chocolates combining the taste of chocolate with different flavors and textures.

Libérez votre créativité et créez des pralines alliant le goût du chocolat à différentes saveurs et textures.

tritan™
from eastman



CLARITY



DURABILITY



SAFETY



STYLE



TRITAN™: MEGLIO DI QUALSIASI ALTRA PLASTICA
TRITAN™: BETTER THAN ANY OTHER PLASTIC
TRITAN™: MIEUX QUE TOUTE AUTRE PLASTIQUE

Gli stampi Chocado sono realizzati con il materiale innovativo Tritan™ che garantisce un eccellente grado di durezza e sicurezza. Tritan™ non contiene BPA, BPS (bisfenolo S) e altri bisfenoli. È questa peculiarità a rendere Tritan™ un materiale adatto al contatto con gli alimenti.

The Chocado moulds are made with the innovative material Tritan™ that provides an excellent level of durability and safety. Tritan™ does not contain BPA, BPS (bisphenol S) or other bisphenols. This fact ensures absolute reliability of these Tritan™ products for food contact.

Les moules Chocado sont réalisés avec le matériau innovant Tritan™ qui garantit un excellent degré de durabilité et de sécurité. Tritan™ ne contient pas de BPA, de BPS (bisphénol S) ou d'autres bisphénols. Cette caractéristique rend les produits en Tritan™ aptes au contact avec les aliments.

KIT DOME 01

Vol. 8 ml

Praline Size:
Ø 26 h 22 mm

24 Pralines / Mould
Item: 52.930.86.0065
Pcs/Master: 10
EAN: 8051085366972

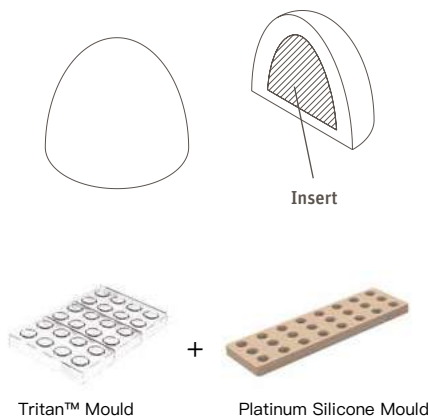

KIT BAR SISMA

Vol. 52 ml

Snack Bar Size:

Silicone Mould 117 x 22 h 12 mm

Volume 8 x 23 ml

Tritan Mould 120 x 25 h 10 mm

Volume 8 x 29 ml

8 Snack Bars / Mould

Item: 52.993.86.0065

Pcs/Master: 10

EAN: 8051085367092

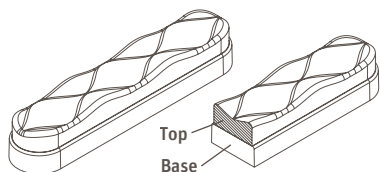

Top
Base

By Marike Van Beurden

Marike



Tritan™ Mould

+



Platinum Silicone Mould



KIT BAR MAGMA

Vol. 53 ml

Snack Bar Size:

Silicone Mould 116 x 23 h 15 mm

Volume 8 x 24 ml

Tritan Mould 120 x 25 h 10 mm

Volume 8 x 29 ml

8 Snack Bars / Mould

Item: 52.994.86.0065

Pcs/Master: 10

EAN: 8051085367153

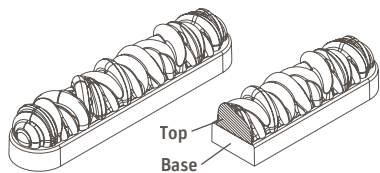

Top
Base

By Marike Van Beurden

Marike



Tritan™ Mould

+



Platinum Silicone Mould



KIT BAR VULCANO

Vol. 52 ml

Snack Bar Size:

Silicone Mould 115 x 20 h 13 mm

Volume 8 x 23 ml

Tritan Mould 120 x 25 h 10 mm

Volume 8 x 29 ml

8 Snack Bars / Mould

Item: 52.995.86.0065

Pcs/Master: 10

EAN: 8051085367207

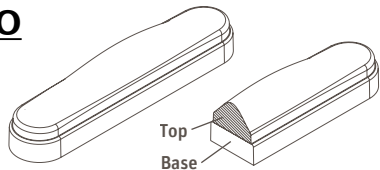

Top
Base

By Marike Van Beurden

Marike



Tritan™ Mould

+



Platinum Silicone Mould



TESORO -P

Vol. 8 ml

Praline Size:
30 x 27 h 16 mm

24 Pralines / Mould
Item: 52.934.86.0065
Pcs/Master: 10
EAN: 8051085367528

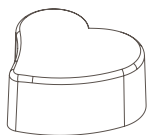

By Kirsten Tibballs

Kirsten Tibballs



Tritan™ Mould



TESORO -B

Vol. 74 ml

Snack Bar Size:
120 x 25 h 12 mm

8 Snack Bars / Mould
Item: 52.935.86.0065
Pcs/Master: 10
EAN: 8051085367566

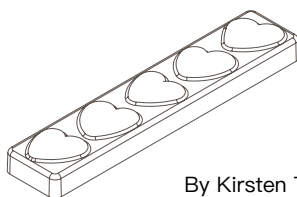

By Kirsten Tibballs

Kirsten Tibballs



Tritan™ Mould

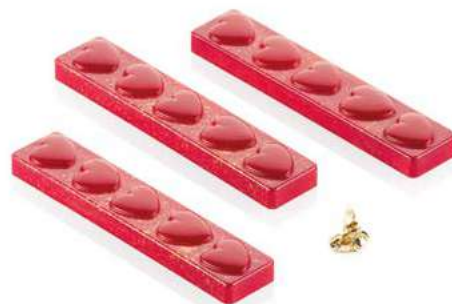

TESORO -T

Vol. 74 ml

Tablette Size:
150 x 70 h 10 mm

3 Tablettes / Mould
Item: 52.936.86.0065
Pcs/Master: 10
EAN: 8051085367627

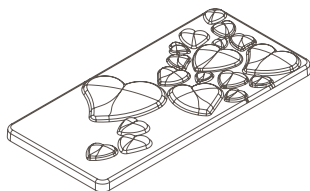

By Kirsten Tibballs

Kirsten Tibballs



Tritan™ Mould



GEMMA -P

Vol. 7,8 ml

Praline Size:
41 x 25 h 15 mm

24 Pralines / Mould
Item: 52.931.86.0065
Pcs/Master: 10
EAN: 8051085367665

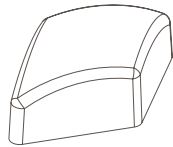

Tritan™ Mould

By Jonathan Mougel

Jonathan Mougel
PÂTISSIER
MEILLEUR OUVRIER DE FRANCE



GEMMA -B

Vol. 53 ml

Snack Bar Size:
114 x 23 h 15 mm

10 Snack Bars / Mould
Item: 52.932.86.0065
Pcs/Master: 10
EAN: 8051085367689

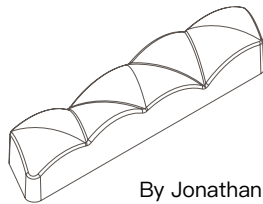

Tritan™ Mould

By Jonathan Mougel

Jonathan Mougel
PÂTISSIER
MEILLEUR OUVRIER DE FRANCE



GEMMA -T

Vol. 92,5 ml

Tablette Size:
150 x 52 h 14 mm

3 Tablettes / Mould
Item: 52.933.86.0065
Pcs/Master: 10
EAN: 8051085367726

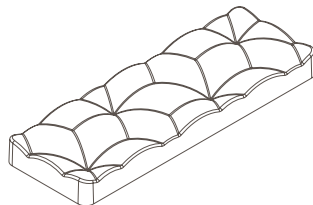

Tritan™ Mould

By Jonathan Mougel

Jonathan Mougel
PÂTISSIER
MEILLEUR OUVRIER DE FRANCE



DEGUSTA 01-P

Vol. 3,2 ml

Tablette Size:
Ø 35 h 5 mm

15 Pralines / Mould
Item: 52.927.86.0065
Pcs/Master: 10
EAN: 8051085351923

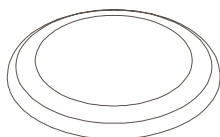

By Luca Bernardini



Tritan™ Mould



DEGUSTA02 -T

Vol. 30 ml

Tablette Size:
95 x 65 h 5 mm

4 Tablettes / Mould
Item: 52.926.86.0065
Pcs/Master: 10
EAN: 8051085367764

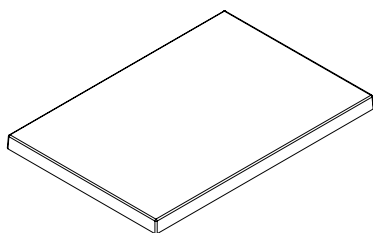

Tritan™ Mould



DEGUSTA 01-T

Vol. 30 ml

Tablette Size:
95 x 65 h 5 mm

4 Tablettes / Mould
Item: 52.925.86.0065
Pcs/Master: 10
EAN: 8051085351749

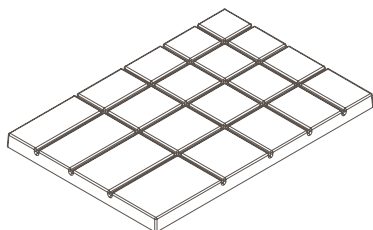

Tritan™ Mould



CUPOLA -P

Vol. 8 ml

Praline Size:

26 x 26 h 16 mm

24 Pralines / Mould

Item: 52.917.86.0065

Pcs/Master: 10

EAN: 8051085351312

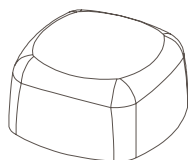

Tritan™ Mould



CUPOLA -B

Vol. 27 ml

Snack Bar Size:

121 x 20,5 h 15,5 mm

8 Snack Bars / Mould

Item: 52.918.86.0065

Pcs/Master: 10

EAN: 8051085351282

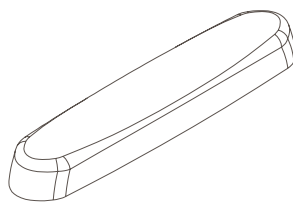

Tritan™ Mould



CUPOLA -T

Vol. 117 ml

Tablette Size:

153 x 74 h 14 mm

3 Tablettes / Mould

Item: 52.919.86.0065

Pcs/Master: 10

EAN: 8051085351138

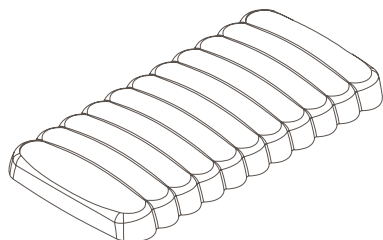

Tritan™ Mould



KIT BLOCCO -T

Vol. 77 ml

Tablette Size:
75 x 75 h 16,5 mm

6 Blocks / Mould
Item: 52.921.86.0065
Pcs/Master: 10
EAN: 8051085351589

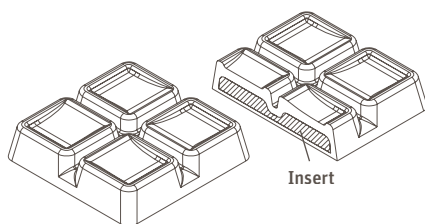

Tritan™ Mould

+



Platinum Silicone Mould



KIT BLOCCO -B

Vol. 38,5 ml

Snack Bar Size:
75,5 x 38 h 16,5 mm

10 Snack Bars / Mould
Item: 52.922.86.0065
Pcs/Master: 10
EAN: 8051085351176

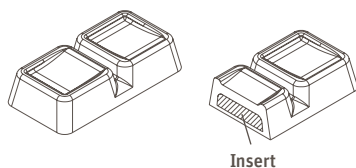

Tritan™ Mould

+



Platinum Silicone Mould



KIT CUORE 01

Vol. 9,4 ml

Praline Size:
35 x 27 h 17 mm

24 Pralines / Mould
Item: 52.920.86.0065
Pcs/Master: 10
EAN: 8051085351688

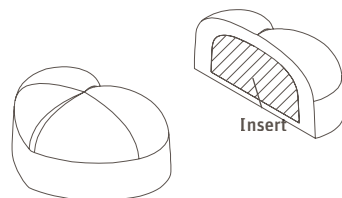

Tritan™ Mould

+



Platinum Silicone Mould



KIT SINFONIA -B

Vol. 42 ml

Snack Bar Size:
120 x 25 h 20,5 mm

10 Snack bars / Mould
Item: 52.924.86.0065
Pcs/Master: 10
EAN: 8051085351213



KIT SINFONIA -T

Vol. 107 ml

Tablette Size:
150 x 50 h 20,5 mm

4 Tablettes / Mould
Item: 2.923.86.0065
Pcs/Master: 10
EAN: 8051085351251

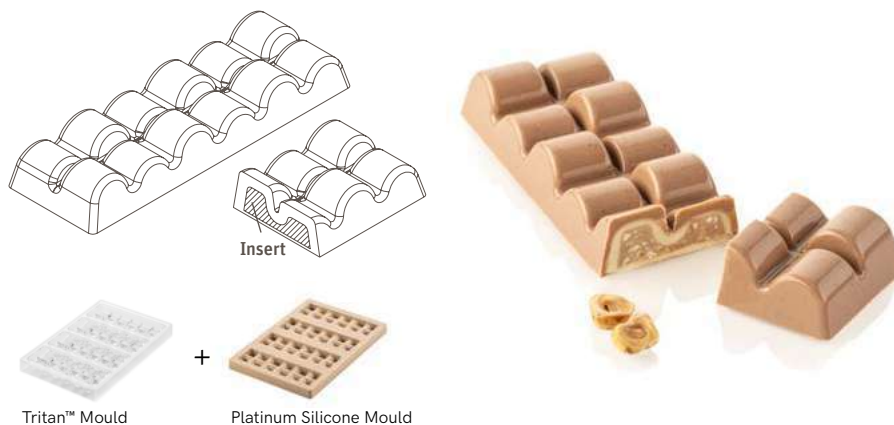

KIT CUBO 01

Vol. 8,5 ml

Praline Size:
21 x 21 h 20 mm

24 Pralines / Mould
Item: 52.929.86.0065
Pcs/Master: 10
EAN: 8051085367023

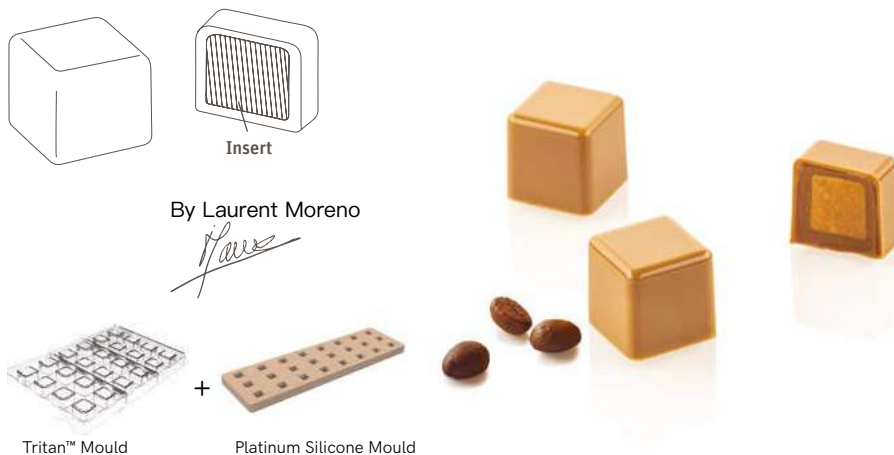

KIT BAR TRONCO

Vol. 48 ml

Snack Bar Size:

Silicone Mould 115 x 20 h 13 mm

Volume: 8 x 19 ml

Tritan Mould 128 x 33 h 14 mm

Volume 8 x 29 ml

8 Snack Bars / Mould

Item: 52.916.86.0065

Pcs/Master: 10

EAN: 8051085351459

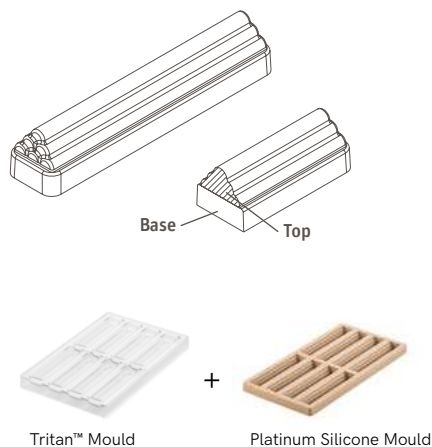

KIT BAR VOLTA

Vol. 52 ml

Snack Bar Size:

Silicone Mould 115 x 20 h 13 mm

Volume: 8 x 23 ml

Tritan Mould 128 x 33 h 14 mm

Volume 8 x 29 ml

8 Snack Bars / Mould

Item: 52.991.86.0065

Pcs/Master: 10

EAN: 8051085351497

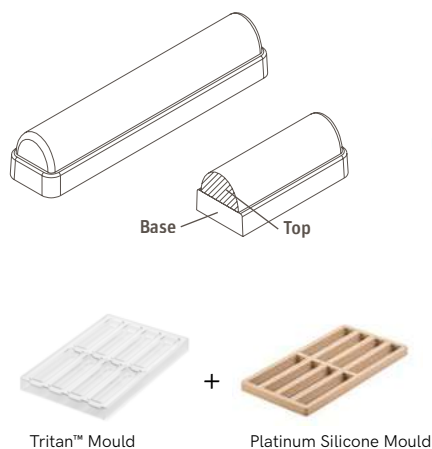

KIT BAR DUNA

Vol. 57 ml

Snack Bar Size:

Silicone Mould 115 x 20 h 13 mm

Volume: 8 x 28 ml

Tritan Mould 128 x 33 h 14 mm

Volume 8 x 29 ml

8 Snack Bars / Mould

Item: 52.992.86.0065

Pcs/Master: 10

EAN: 8051085351534

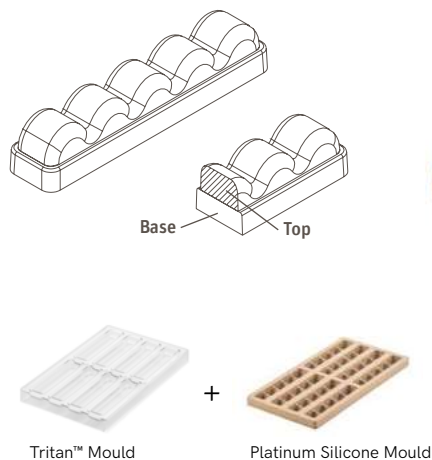

KIT SEMISFERA 01

Vol. 8,5 ml

Praline Size:
Ø 31 mm h 16,5 mm

24 Pralines / Mould
Item: 52.913.86.0065
Pcs/Master: 10
EAN: 8051085335633

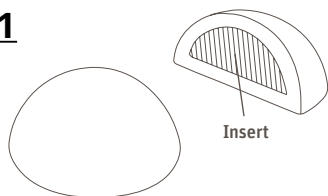

Tritan™ Mould

Platinum Silicone Mould



KIT OVALE 01

Vol. 8,5 ml

Praline Size:
23 x 33 h 15 mm

24 Pralines / Mould
Item: 52.914.86.0065
Pcs/Master: 10
EAN: 8051085335831

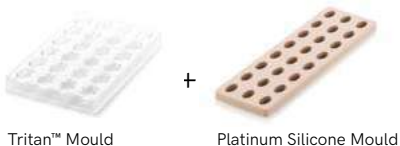
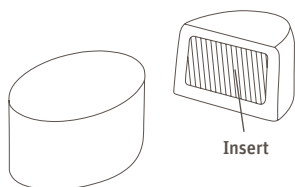

Tritan™ Mould

Platinum Silicone Mould



KIT QUADRO 01

Vol. 8,9 ml

Praline Size:
25 x 25 h 15 mm

24 Pralines / Mould
Item: 52.915.86.0065
Pcs/Master: 10
EAN: 8051085335855

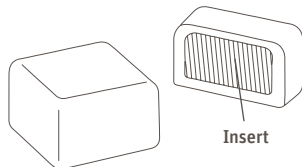

Tritan™ Mould

Platinum Silicone Mould

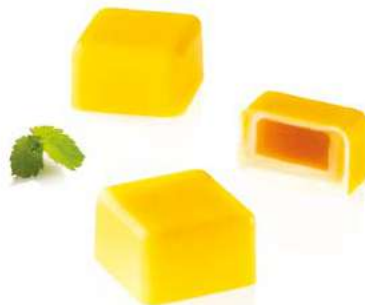

ONDA -P**Vol. 8 ml**

Praline Size:
28 x 28 h 13 mm

24 Pralines / Mould
Item: 52.901.86.0065
Pcs/Master: 10
EAN: 8051085335466

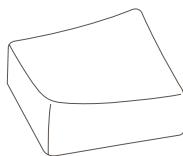

Tritan™ Mould

By David Vidal

**ONDA -B****Vol. 26 ml**

Snack Bar Size:
120 x 20 h 15 mm

10 Snack Bars / Mould
Item: 52.903.86.0065
Pcs/Master: 10
EAN: 8051085335503

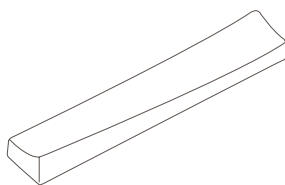

Tritan™ Mould

By David Vidal

**ONDA -T****Vol. 85 ml**

Tablette Size:
150 x 70 h 11 mm

3 Tablettes / Mould
Item: 52.902.86.0065
Pcs/Master: 10
EAN: 8051085335480

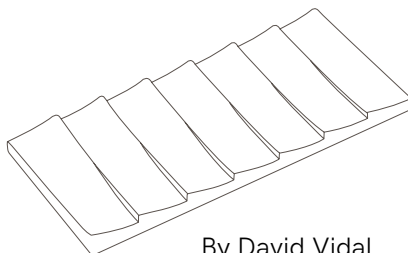

Tritan™ Mould

By David Vidal



GOCCIA -P

Vol. 8 ml

Praline Size:
29 x 41 h 14 mm

24 Pralines / Mould
Item: 52.907.86.0065
Pcs/Master: 10
EAN: 8051085335404

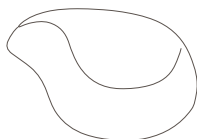

Tritan™ Mould

By Kirsten Tibballs

Kirsten Tibballs



GOCCIA -B

Vol. 30 ml

Snack Bar Size:
120 x 25 h 16 mm

8 Snack Bars / Mould
Item: 52.909.86.0065
Pcs/Master: 10
EAN: 8051085335381

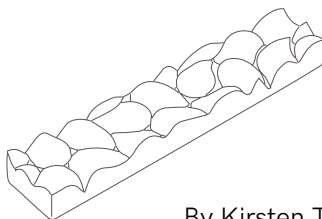

Tritan™ Mould

By Kirsten Tibballs

Kirsten Tibballs



GOCCIA -T

Vol. 80 ml

Tablette Size:
150 x 70 h 8,3 mm

3 Tablettes / Mould
Item: 52.908.86.0065
Pcs/Master: 10
EAN: 8051085335367

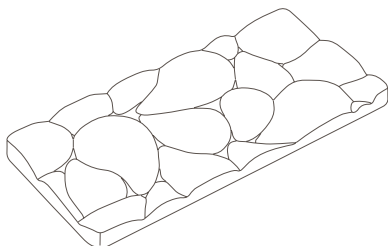

Tritan™ Mould

By Kirsten Tibballs

Kirsten Tibballs



BOLLA -P

Vol. 8 ml

Praline Size:
25 x 40 h 14 mm

24 Pralines / Mould
Item: 52.910.86.0065
Pcs/Master: 10
EAN: 8051085335305



Tritan™ Mould



BOLLA -B

Vol. 25 ml

Snack Bar Size:
115 x 25 h 15 mm

10 Snack Bars / Mould
Item: 52.912.86.0065
Pcs/Master: 10
EAN: 8051085335329

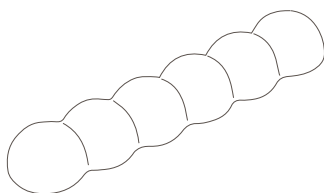

Tritan™ Mould



BOLLA -T

Vol. 68 ml

Tablette Size:
156 x 61 h 14 mm

4 Tablettes / Mould
Item: 52.911.86.0065
Pcs/Master: 10
EAN: 8051085335220

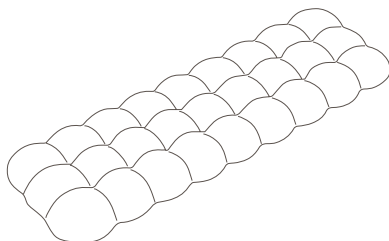

Tritan™ Mould



RIGA -P

Vol. 8 ml

Praline Size:

47 x 15 h 16 mm

24 Pralines / Mould

Item: 52.904.86.0065

Pcs/Master: 10

EAN: 8051085335442

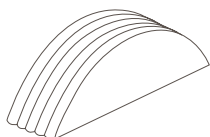

Tritan™ Mould



RIGA -B

Vol. 25 ml

Snack Bar Size:

119 x 18 h 17 mm

10 Snack Bars / Mould

Item: 52.906.86.0065

Pcs/Master: 10

EAN: 8051085335428

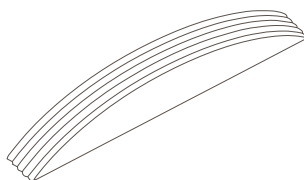

Tritan™ Mould



RIGA -T

Vol. 68 ml

Tablette Size:

150 x 55 h 9 mm

4 Tablettes / Mould

Item: 52.905.86.0065

Pcs/Master: 10

EAN: 8051085335343

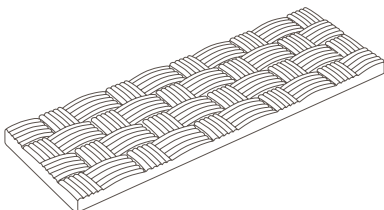

Tritan™ Mould



FORCHETTA 2 REBBI

Item: 70.174.99.0001
 Pcs/Master: 12
 EAN: 8051085336449

**FORCHETTA 3 REBBI**

Item: 70.175.99.0001
 Pcs/Master: 12
 EAN: 8051085336456

**FORCHETTA A SPIRALE**

Item: 70.173.99.0001
 Pcs/Master: 12
 EAN: 8051085336432

**SPATOLE ANGOLARI****SP-ANG 20**

Size: 20 cm
 Item: 73.435.99.0001
 EAN: 8051085195053

SP-ANG 33

Size: 33 cm
 Item: 73.436.99.0001
 EAN: 8051085195060

SP-ANG 38

Size: 38 cm
 Item: 73.438.99.0001
 EAN: 8051085215850



PVC SHEETS

Item: 73.479.86.0001
50 pcs - Size: 60 x 40 cm
EAN: 8051085279388



FOGLI CHITARRA

Item: 73.480.86.0001
50 pcs - Size: 60 x 40 cm
EAN: 8051085333646



STEEL SPATULA

Item: 70.141.00.0001
Size: 120 mm x h 120 mm
EAN: 8051085201396



SCRAPER

SCRAPER 130 MM

Item: 70.157.99.0001
Size: 130 mm x h 15 mm
EAN: 8051085286782



SCRAPER 175 MM

Item: 70.158.99.0001
Size: 175 mm x h 12 mm
EAN: 8051085286799

SCRAPERS WITH HANDLE

SCRAPER 170 MM

Item: 70.171.99.0001
Size: 170 mm x h 60 mm
Pcs/Master: 12
EAN: 4028574009744

SCRAPER 270 MM

Item: 70.172.99.0001
Size: 270 mm x h 55 mm
Pcs/Master: 24
EAN: 4028574009751





3D CHOCO FIGURES



TERMOFORMATI

Kit di stampi termoformati riutilizzabili creati dai designer di Silikomart per la realizzazione di soggetti 3D in cioccolato.

Reusable thermoformed moulds kits created by Silikomart designers for the creation of 3D chocolate subjects.

Kit de moules thermoformés réutilisables créés par les designers de Silikomart pour la réalisation d'un sujet 3D en chocolat.

Modo d'uso:

- 1 - Riempire gli stampi con il cioccolato temperato quindi capovolgere lo stampo su una griglia e lasciar colare il cioccolato in eccesso. Ripetere l'operazione fino ad ottenere lo spessore desiderato.
- 2 - Lasciare lo stampo capovolto sulla griglia fino a completa cristallizzazione del cioccolato (circa 4 ore).
- 3 - Una volta che il cioccolato si è rappreso sformare sbattendo delicatamente gli stampi sul piano di lavoro, i vari componenti in cioccolato si staccheranno facilmente. Qualora non accadesse esercitare una leggera pressione sullo stampo spingendo la sagoma in cioccolato verso l'esterno.
- 4 - Incollare i componenti tra loro utilizzando del cioccolato fuso o scaldandone le estremità con un rapido passaggio su una teglia calda.

How to use:

- 1 - Fill the moulds with tempered chocolate then turn the mould upside down on a grid. Repeat the process until you will get the aimed thickness.
- 2 - Leave the mould upside down on the grid until the chocolate is completely crystallized (about 4 hours).
- 3 - Once the chocolate has set, unmould by gently tapping the moulds on the working surface, the chocolate components will come off easily. If this does not happen, apply a light pressure on the mould by pushing the chocolate shape outwards.
- 4 - Stick the components together using melted chocolate or warm up the edges with a quick passage on a hot baking tray.

Mode d'emploi:

- 1 - Remplir les moules de chocolat tempéré puis retourner le moule sur une grille et laisser couler l'excès de chocolat. Répéter l'opération jusqu'à obtenir l'épaisseur souhaitée.
- 2 - Laisser le moule à l'envers sur la grille jusqu'à cristallisation complète du chocolat (environ 4 heures).
- 3 - Une fois que le chocolat a cristallisé, démouler en frappant doucement les moules sur la surface de travail, les différents composants de chocolat se détacheront facilement. Si cela ne se produit pas, appliquer une légère pression sur le moule en poussant la forme de chocolat vers l'extérieur.
- 4 - Coller les composants ensemble à l'aide d'un peu de chocolat fondu ou en chauffant les extrémités avec un rapide passage sur une plaque chaude.

NEST

Item: 70.613.99.0065
Size: 58 x 116 h 150 mm
Pcs/Master: 4
EAN: 8051085379842

NEW

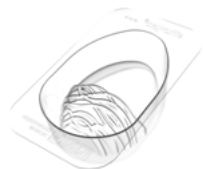

Lato A
Side A
Face A

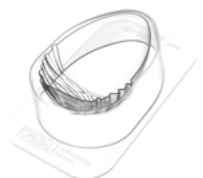

Lato B
Side B
Face B



DRIPPY

Item: 70.614.99.0065
Size: 55 x 113 h 153 mm
Pcs/Master: 4
EAN: 8051085379880

NEW



Lato A
Side A
Face A



Lato B
Side B
Face B



WINTER TREE

Item: 70.612.99.0065
 Size: Ø 108 h 210 mm
 Pcs/Master: 4
 EAN: 8051085374533



Lato A
 Side A
 Face A



Lato B
 Side B
 Face B

**LOVING BIRDS**

Item: 70.608.99.0065
 Size: 145 x 118 h 32 mm
 Pcs/Master: 4
 EAN: 8051085346271



Lato A
 Side A
 Face A



Lato B
 Side B
 Face B



FROSTY

Item: 70.611.99.0065
Size: 74 x 194 h 78 mm
Pcs/Master: 4
EAN: 8032539937528



Lato A
Side A
Face A



Lato B
Side B
Face B



SECRET LOVE

Item: 70.609.99.0065
Size Big: 123 x 115 h 44 mm
Size Small: 93 x 99 h 36 mm
Pcs/Master: 4
EAN: 8051085346714



Lato A
Side A
Face A



Lato B
Side B
Face B



SMILING EGGS

Item: 70.610.99.0065
 Size: 77 x 108 h 82 mm
 Pcs/Master: 4
 EAN: 8051085346806

Lato A
 Side A
 Face A



Lato B
 Side B
 Face B

**PUMPKIN**

Item: 70.607.99.0065
 Size: Ø 138 h 103 mm
 Pcs/Master: 4
 EAN: 8051085340057

Lato A
 Side A
 Face A



Lato B
 Side B
 Face B

**MARTINO**

Item: 70.606.99.0065
 Size: 121 x 67 h 185 mm
 Pcs/Master: 4
 EAN: 8051085340026

Lato A
 Side A
 Face A



Lato B
 Side B
 Face B



LADY COCCA

Item: 70.603.99.0065
 Size: 250 x 150 h 58 mm
 Pcs/Master: 4
 EAN: 8051085333318

Lato A
 Side A
 Face A



Lato B
 Side B
 Face B



PAUL CINO

Item: 70.602.99.0065
 Size: 250 x 150 h 58 mm
 Pcs/Master: 4
 EAN: 8051085333288

Lato A
 Side A
 Face A



Lato B
 Side B
 Face B



LUCKY BUNNY

Item: 70.601.99.0065
 Size: 285 x 150 h 58 mm
 Pcs/Master: 4
 EAN: 8051085333257

Lato A
 Side A
 Face A



Lato B
 Side B
 Face B







EASY CHOC

EASYCHOC

Una selezione di prodotti per realizzare deliziosi cioccolatini fatti in casa.
A selection of products to create delicious homemade chocolates
Une sélection de produits pour réaliser des délicieux chocolats maison

3D CHOCO

Una nuova gamma di stampi dedicati ai cioccolatini in 3D. Piccole dolcezze al cioccolato che vi sorprenderanno per la loro forma originale e in 3D!

A brand new range of silicone moulds dedicated to 3D chocolates Little chocolate treats that will surprise you with their original 3D shape!

Une nouvelle collection de moules en silicone dédiée aux chocolats en 3D! Petits chocolats qui vous surprendront avec leur forme originale et en 3D!

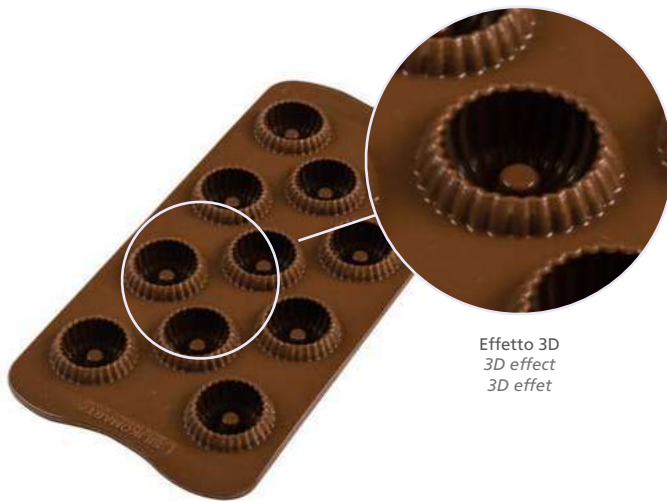

Effetto 3D
3D effect
3D effet

CHOCO EGG

Item: 22.158.77.0065
Size: Ø 23 h 30 mm
Volume: 15 x 8 ml Tot.: 120 ml
Pcs/Master: 30
EAN: 8051085363827



Effetto 3D
3D effect
3D effet



WINTER BALL

Item: 22.160.77.0065
Size: Ø 27 h 25 mm
Volume: 14 x 8 ml Tot.: 112 ml
Pcs/Master: 30
EAN: 8051085373574



Effetto 3D
3D effect
3D effet



KISS

Item: 22.157.77.0065
Size: Ø 28,3 h 23,7 mm
Volume: 15 x 8,5 ml Tot.: 127,5 ml
Pcs/Master: 36
EAN: 8051085356614



Effetto 3D
3D effect
3D effet



SCG056 MR & MRS BROWN

Item: 22.156.77.0065
 Size: Ø 25 h 40 mm
 Volume: 15 x 10 ml Tot.: 150 ml
 Pcs/Master: 18
 EAN: 8032539937436

PH credit: Matteo Felici



Effetto 3D
 3D effect
 3D effet

**SCG055 AMLETO**

Item: 22.155.77.0065
 Size: 29 x 32 h 21 mm
 Volume: 12 x 10 ml Tot.: 120 ml
 Pcs/Master: 36
 EAN: 8051085338627

PH credit: Matteo Felici



Effetto 3D
 3D effect
 3D effet

**SCG054 CHOCO TREES**

Item: 22.154.77.0065
 Size: Ø 28 h 30 mm
 Volume: 15 x 8,5 ml Tot.: 128 ml
 Pcs/Master: 30
 EAN: 8032539936118

PH credit: Matteo Felici



Effetto 3D
 3D effect
 3D effet



SCG053 CHOCO DROP

Item: 22.153.77.0065
Size: Ø 23 h 30 mm
Volume: 15 x 8 ml Tot.: 120 ml
Pcs/Master: 30
EAN: 8051085323395



Effetto 3D
3D effect
3D effet



SCG052 CHOCO SPIRAL

Item: 22.152.77.0165
Size: Ø 24 h 30 mm
Volume: 15 x 9 ml Tot.:135 ml
Pcs/Master: 30
EAN: 8051085323456



Effetto 3D
3D effect
3D effet



SCG47 CHOCO FLAME

Item: 22.147.77.0065
Size: Ø 27 h 28 mm
Volume: 15 x 8 ml Tot.: 120 ml
Pcs/Master: 30
EAN: 8051085293841



Effetto 3D
3D effect
3D effet



SCG49 CHOCO CROWN

Item: 22.149.77.0065

Size: Ø 30 h 15 mm

Volume: 11 x 9 ml Tot.: 99 ml

Pcs/Master: 36

EAN: 8051085293926



Effetto 3D
3D effect
3D effet

**SCG48 MY LOVE**

Item: 22.148.77.0065

Size: 31 x 30 h 15 mm

Volume: 12 x 8 ml Tot.: 96 ml

Pcs/Master: 36

EAN: 8051085293872



Effetto 3D
3D effect
3D effet

**SCG50 TARTUFINO**

Item: 22.150.77.0065

Size: Ø 25 h 22 mm

Volume: 15 x 8 ml Tot.: 120 ml

Pcs/Master: 36

EAN: 8051085312368



Effetto 3D
3D effect
3D effet



SCG51 CHOCO GAME

Item: 22.151.77.0165

Size: 22 x 22 h 20 mm

Volume: 15 x 8 ml Tot.: 120 ml

Pcs/Master: 36

EAN: 8051085312412



Effetto 3D
3D effect
3D effet



CHOCO FRITURE

Item: 22.159.77.0065

size 34 x 32 mm

volume 4 ml x 2 Tot. 8 ml

size 35 x 27 mm

volume 4 ml x 2 Tot. 8 ml

size 41 x 17 mm

volume 4 ml x 2 Tot. 8 ml

size 43 x 38 mm

volume 5 ml x 2 Tot. 10 ml

size 35 x 26 mm

volume 3 ml x 2 Tot. 6 ml

Pcs/Master: 36

EAN: 8051085368495



SCG01 MONAMOUR

Item: 22.101.77.0065
 Size: 30 x 22 h 25 mm
 Volume: 15 x 10 ml Tot.: 150 ml
 Pcs/Master: 36
 EAN: 8051085019090

**SCG02 CUBO**

Item: 22.102.77.0065
 Size: 26 x 26 h 18 mm
 Volume: 15 x 10 ml Tot.: 150 ml
 Pcs/Master: 36
 EAN: 8051085019106

**SCG03 IMPERIAL**

Item: 22.103.77.0065
 Size: Ø 28 h 20 mm
 Volume: 15 x 10 ml Tot.: 150 ml
 Pcs/Master: 36
 EAN: 8051085019113

**SCG04 VERTIGO**

Item: 22.104.77.0065
 Size: Ø 28 h 20 mm
 Volume: 15 x 10 ml Tot.: 150ml
 Pcs/Master: 36
 EAN: 8051085019120



SCG05 EASTER

Item: 22.105.77.0065
 Size: 30 x 43 h16 mm
 Volume: 14 x 6 ml Tot.: 84 ml
 Pcs/Master: 36
 EAN: 8051085021130

**SCG06 CHRISTMAS**

Item: 22.106.77.0065
 Size: 34 x 34 h18 mm
 Volume: 12 x 7 ml Tot.: 84 ml
 Pcs/Master: 36
 EAN: 8051085021147

**SCG07 PRALINE**

Item: 22.107.77.0065
 Size: Ø 30 h 18 mm
 Volume: 15 x 10 ml Tot.: 150 ml
 Pcs/Master: 36
 EAN: 8051085021154

**SCG08 FLEURY**

Item: 22.108.77.0065
 Size: 30 x 30 h 15 mm
 Volume: 15 x 9 ml Tot.: 135 ml
 Pcs/Mmaster: 36
 EAN: 8051085021161

**SCG09 JACK**

Item: 22.109.77.0065
 Size: 37 x 20 h 20 mm
 Volume: 14 x 8 ml Tot.: 112 ml
 Pcs/Master: 36
 EAN: 8051085021178



SCG10 NATURE

Item: 22.110.77.0065
 Size: 51 x 23 h 4 mm
 Volume: 8 x 11 ml Tot.: 88 ml
 Pcs/Master: 36
 EAN: 8051085021185



SCG11 TABLETTE

Item: 22.111.77.0065
 Size: 38 x 28 h 4 mm
 Volume: 12 x 4 ml Tot.: 48 ml
 Pcs/Master: 36
 EAN: 8051085022380



SCG12 MR GINGER

Item: 22.112.77.0065
 Size: 43 x 35 h 12 mm
 Volume: 12 x 7 ml Tot.: 84 ml
 Pcs/Master: 36
 EAN: 8051085022397



SCG13 ROSE

Item: 22.113.77.0065
 Size: Ø 28 h 18 mm
 Volume: 15 x 7 ml Tot.: 105 ml
 Pcs/Master: 36
 EAN: 8051085022496



SCG16 DINO

Item: 22.116.77.0065
 Size: 40 x 33 h 16 mm
 Volume: 12 x 8 ml Tot.: 96 ml
 Pcs/Master: 36
 EAN: 8051085022526



SCG17 TEATIME

Item: 22.117.77.0065
 Size: 43,6 x 29 h 15 mm
 Volume: 12 x 7 ml Tot.: 84 ml
 Pcs/Master: 36
 EAN: 8051085024209



SCG19 FANTASIA

Item: 22.119.77.0065
 Size: Ø 28 h 15 mm
 Volume: 15 x 8 ml Tot.: 120 ml
 Pcs/Master: 36
 EAN: 8051085044528



SCG20 KONO

Item: 22.120.77.0065
 Size: Ø 26 h 28 mm
 Volume: 15 x 7 ml Tot.: 105 ml
 Pcs/Master: 30
 EAN: 8051085044566



SCG21 CHOCO MACARON

Item: 22.121.77.0065
 Size: Ø 26 h 28 mm
 Volume: 15 x 3 ml Tot.: 45 ml
 Pcs/Master: 36
 EAN: 8051085172146



SCG23 CHOCO WINTER

Item: 22.123.77.0065
 Size: 33 x 27 h 15 mm
 Volume: 15 x 8 ml Tot.: 120 ml
 Pcs/Master: 36
 EAN: 8051085191949



SCG24 CHOCO SPRINGLIFE

Item: 22.124.77.0065
 Size: 36 x 26 h 15 mm
 Volume: 15 x 7 ml Tot.: 105 ml
 Pcs/Master: 36
 EAN: 8051085191994



SCG26 CHOCO GUFU

Item: 22.126.77.0065
 Size: 34 x 30 h 15 mm
 Volume: 15 x 7 ml Tot.: 105 ml
 Pcs/Master: 36
 EAN: 8051085210831



SCG27 CHOCO ANGELS

Item: 22.127.77.0065
 Size: 35 x 30 h 16 mm
 Volume: 12 x 9 ml Tot.: 108 ml
 Pcs/Master: 36
 EAN: 8051085218271



SCG28 CHOCO SPOON

Item: 22.128.77.0065
 Size: 96 x 26 h 16 mm
 Volume: 7 x 6 ml Tot.: 42 ml
 Pcs/Master: 36
 EAN: 8051085221868



SCG29 CHOCO BOTTOM

Item: 22.129.77.0065
 Size: Ø 35 h 36 mm
 Volume: 15 x 3 ml Tot.: 45 ml
 Pcs/Master: 36
 EAN: 8051085221912



SCG30 EASTER FRIENDS

Item: 22.130.77.0065
 Size: 34 x 34 h 18 mm
 Volume: 12 x 8 ml Tot.: 96 ml
 Pcs/Master: 36
 EAN: 8051085223268



SCG32 CHOCO FRUITS

Item: 22.132.77.0065
 Size: 35 x 32 h 15 mm
 Volume: 15 x 6 ml Tot.: 90 ml
 Pcs/Master: 36
 EAN: 8051085249664



SCG33 CHOCO KEYS

Item: 22.133.77.0065
 Size: 34 x 84 h14 mm
 Volume: 8 x 12 ml Tot.: 96 ml
 Pcs/Master: 36
 EAN: 8051085243587





SCG34 CHOCO GOAL

Item: 22.134.77.0065
 Size: Ø 27 h 14 mm
 Volume: 18 x 5 ml Tot.: 90 ml
 Pcs/Master: 36
 EAN: 8051085252060



SCG35 CHOCO PIGS

Item: 22.135.77.0065
 Size: 31 x 29 h 15 mm
 Volume: 15 x 6 ml Tot.: 90 ml
 Pcs/Master: 36
 EAN: 8051085252107



SCG36 CLASSIC CHOCO BAR

Item: 22.136.77.0065
 Size: 155 x 77 h 9 mm
 Volume: 92 ml
 Pcs/Master: 36
 EAN: 8051085259267



SCG37 TABLETTE CHOCO BAR

Item: 22.137.77.0065
 Size: 154 x 77 h 9 mm
 Volume: 91 ml
 Pcs/Master: 36
 EAN: 8051085259298



SCG38 LOVE CHOCO BAR

Item: 22.138.77.0065
 Size: 155 x 76 h 8,5 mm
 Volume: 85 ml
 Pcs/Master: 36
 EAN: 8051085259328



SCG40 CHOCO FROZEN

Item: 22.140.77.0065
 Size: Ø 35 h 4 mm
 Volume: 14 x 2 ml Tot.: 28 ml
 Pcs/Master: 36
 EAN: 8051085259892



SCG41 XMAS CHOCO BUTTONS

Item: 22.141.77.0065
 Size: 35 x 35 h 6 mm
 Volume: 15 x 3 ml Tot.: 45ml
 Pcs/Master: 36
 EAN: 8051085261338



SCG42 STARFISH

Item: 22.142.77.0065
 Size: 34 x 34 h 15 mm
 Volume: 14 x 6 ml Tot.: 84 ml
 Pcs/Master: 36
 EAN: 8051085278800



SCG43 CHOCO MELODY

Item: 22.143.77.0065
 Size: Ø 36 h 24 mm
 Volume: 14 x 5 ml Tot.: 70 ml
 Pcs/Master: 36
 EAN: 8051085284634



SCG45 WINTER STARS

Item: 22.145.77.0065
 Size: Ø 30 h 15 mm
 Volume: 15 x 7 ml Tot.: 105 ml
 Pcs/Master: 36
 EAN: 8051085285242



SCG46 CHOCO PINE

Item: 22.146.77.0065
 Size: 56 x 75 h 8 mm
 Volume: 4 x 14 ml Tot.: 56 ml
 Pcs/Master: 36
 EAN: 8051085291823



SF125 CHOCOGIANDUIA

Item: 26.125.77.0065
 Size: 50 x 18 h 23 mm
 Volume: 24 x 14 ml Tot.: 336 ml
 Pcs/master: 3
 EAN: 8051085045365



SF129 MINI BUCHE

Item: 26.129.77.0065
 Size: 44 x 18 h 20 mm
 Volume: 30 x 14 ml Tot.: 420 ml
 Pcs/master: 6
 EAN: 8051085200702



SF151 CHOCO FLASH

Item: 26.151.77.0065
 Size: Ø 52 h 5 mm
 Volume: 11 x 8 ml Tot.: 88 ml
 Pcs/master: 6
 EAN: 8051085251964



SF169 CHOCO ABC

Item: 26.169.77.0065
 Volume: 81 x 1,5 ml Tot.: 103,5 ml
 Pcs/master: 6
 EAN: 8051085200498



SF174 CHOCO 123

Item: 26.174.77.0065
 Volume: 60 x 2 ml Tot.: 120 ml
 Pcs/master: 6
 EAN: 8051085200542



SF184 MY SNACK

Item: 26.184.77.0065
 Size: 100 x 26 h 16 mm
 Volume: 8 x 40 ml Tot.: 320 ml
 Pcs/master: 4
 EAN: 8051085235780



SF198 WINTER CHOCO TAGS

Item: 26.198.77.0065
 Size: 37 x 60 h 8 mm
 Volume: 16 x 9 ml Tot.: 144 ml
 Pcs/master: 6
 EAN: 8051085243662





SF199 FUNNY OWLS CHOCO TAGS

Item: 26.199.77.0065
 Size: 62 x 40 h 8 mm
 Volume: 4 x 11 ml - 4 x 9,2 ml - 4 x 11 ml - 4 x 9,2 ml
 Pcs/master: 6
 EAN: 8051085243686



SF173 CHOCOLAT

Item: 26.173.77.0065
 Size: 257 x 152 h 26 mm
 Volume: 10 x 88 ml Tot.: 880
 Pcs/master: 3
 EAN: 8051085200924



SF213 CHOCO BLOCK

Item: 26.213.77.0065
 Size: 90 x 45 h 28 mm
 Volume: 10 x 75 ml Tot.: 750 ml
 Pcs/master: 3
 EAN: 8051085260072



CKC01 SNOWMAN SLIM

Item: 22.161.77.0165
 Size: 47 x 57 h 5 mm
 Volume: 6 x 5,5 ml Tot.: 33 ml
 Pcs/master: 6
 EAN: 8051085206193



CKC02 COOKIE XMAS SLIM

Item: 22.162.77.0165
 Size: Ø 57 h 5 mm
 Volume: 6 x 5,6 ml Tot.: 34 ml
 Pcs/master: 6
 EAN: 8051085011773



CKC04 COOKIE GNAM GNAM SLIM

Item: 22.164.77.0165
 Size: 47 x 57 h 5 mm
 Volume: 6 x 5,5 ml Tot.: 33 ml
 Pcs/master: 12
 EAN: 8051085203659

**CKC05 COOKIE DOLCE VITA SLIM**

Item: 22.165.77.0165
 Size: Ø 57 h 5 mm
 Volume: 6 x 5,6 ml Tot.: 34 ml
 Pcs/master: 12
 EAN: 8051085203666

**CKC06 COOKIE LOVE SLIM**

Item: 22.166.77.0165
 Size: 64 x 63 h 5 mm
 Volume: 6 x 8,6 ml Tot.: 51 ml
 Pcs/master: 12
 EAN: 8051085203673

**CKC12 COOKIE MONSTERS SLIM**

Item: 22.172.77.0165
 Size: 47 x 57 h 5 mm
 Volume: 6 x 5,5 ml Tot.: 33 ml
 Pcs/master: 12
 EAN: 8051085214495

**CKC14 EASTER SLIM**

Item: 22.174.77.0165
 Size: Ø 57 h 5 mm
 Volume: 6 x 5,6 ml Tot.: 34 ml
 Pcs/master: 12
 EAN: 8051085222728

**ACC086 - FUNNEL CHOC**

Item: 70.095.99.0065
 Size: Ø 130 h 140 mm
 Volume: 1000 ml
 Pcs/master: 3
 EAN: 8051085023806

**THERMO CHOC**

Item: 70.096.98.0062
 Size: 320 x 70 h 30 mm
 Pcs/master: 12
 EAN: 8051085232178

**901008 LOVE**

Item: 70.252.00.0060
 Size: 50 x 40 h 7 mm
 Pcs/master: 10
 EAN: 8051085312900

**904013 CANDELE**

Item: 70.237.00.0060
 Size: 42 x 60 h 13 mm
 Pcs/master: 10
 EAN: 8051085139613

**901018 ORSETTO
CUORE**

Item: 70.218.99.0060
 Size: Ø 23 h 5 mm
 EAN: 8032539938372

**902020 MUSETTO
CONIGLIO**

Item: 70.220.99.0060
 Size: 656 x 40 h 9 mm
 EAN: 8032539938396

**902025 OVETTO
FANTASIA**

Item: 70.206.99.0060
 Size: 42 x 30 h 14 mm
 EAN: 8032539938402

**9011210 ANIMALI
VARI**

Item: 70.068.99.0060
 Size: 48 x 29 h 8 mm
 EAN: 8032539938549

**9013026 FIORE**

Item: 70.089.99.0060
 Size: Ø 36 h 7 mm
 EAN: 8032539938587

**904010 AGRIFOGLIO**

Item: 70.088.99.0060
 Size: 50 x 70 h 4 mm
 EAN: 8032539938440

**SK 3000 UOVO**

Item: 70.071.99.0060
 Size: 140 x 100 h 50 mm
 EAN: 8032539938662

**SK 4000 UOVO**

Item: 70.201.99.0060
 Size: 220 x 160 h 80 mm
 EAN: 8032539938679



THE NEW TRADITION

THE NEW TRADITION

Un ritorno alle origini, alle basi, ai capisaldi della pasticceria. La riscoperta di forme classiche, intramontabili, che non vi stancherete mai di riproporre per le vostre creazioni. Riscoprite il piacere di creare grazie agli stampi Silikomart che trasformeranno in realtà le vostre ricette più golose garantendo un risultato perfetto sin dalla prima infornata.

A return to the roots, to the basics, to the milestones of the bakery. The rediscovery of the classic and timeless shapes, that you will never get tired of using for your creations. You will find again the pleasure of baking thanks to the silicone moulds by Silikomart that will make your recipes a reality with a perfect result since the first baking.

Un retour aux racines, aux bases, aux pierres angulaires de la pâtisserie. La réinvention des formes classiques, intemporelles, vous n'en avez jamais marre de faire vos créations. Redécouvrez le plaisir de créer grâce aux moules en silicone Silikomart qui transformeront en réalité vos recettes plus gourmandes tout en assurant un résultat parfait dès première fois.

CLASSIC PREMIUM

Questa linea di stampi Silikomart è disegnata per ricreare l'atmosfera della pasticceria tradizionale rivisitata in chiave moderna.

This moulds line by Silikomart is designed in order to recreate the atmosphere of the traditional bakery reinterpreted with a modern twist.

Cette ligne de moules Silikomart est conçue pour recréer l'atmosphère de la pâtisserie traditionnelle revisitée au style moderne.

SFT126 STAMPO ROTONDO

Item: 20.126.00.0065
Size: Ø 260 h 45 mm
Volume: 2200 ml
Pcs/Master: 6
EAN: 8032539932080



SFT180 GÉNOISE

Item: 20.180.00.0065
Size: Ø 180 h 65 mm
Volume: 1500 ml
Pcs/Master: 6
EAN: 8051085294909



SFT205 CIAMBELLONE

Item: 20.205.00.0065
Size: Ø 240 h 55 mm
Volume: 1500 ml
Pcs/Master: 4
EAN: 8032539934459



SFT426 CROSTATÀ

Item: 20.426.00.0065
Size: Ø 260 h 30 mm
Volume: 1300 ml
Pcs/Master: 4
EAN: 8032539932387



SFT250 GUGELHUPF

Item: 20.250.00.0065
 Size: Ø 220 h 110 mm
 Volume: 2200 ml
 Pcs/Master: 6
 EAN: 8032539932288

**SFT330 PLUM CAKE**

Item: 20.330.00.0065
 Size: 260 x 100 h 70 mm
 Volume: 1500 ml
 Pcs/Master: 6
 EAN: 8032539932349

**SF002 HALF SPHERE**

Item: 20.002.00.0065
 Size: Ø 70 h 35 mm
 Volume: 6 x 80 ml Tot.: 480 ml
 Pcs/Master: 10
 EAN: 8032539930253

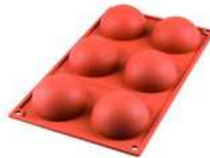
**SF006 SEMISFERA**

Item: 20.006.00.0065
 Size: Ø 30 h15 mm
 Volume: 24 x 10 ml Tot.: 240 ml
 Pcs/Master: 10
 EAN: 8032539930376



SF026 MINI CAKE

Item: 20.026.00.0065
 Size: 79 x 29 h 30 mm
 Volume: 12 x 70 ml Tot.: 840 ml
 Pcs/Master: 10
 EAN: 8032539930970



SF058 MINI GUGELHUPF

Item: 20.058.00.0065
 Size: Ø 70 h 36 mm
 Volume: 6 x 80 ml Tot.: 480 ml
 Pcs/Master: 10
 EAN: 8032539931939



SF022 MINI MUFFIN

Item: 20.022.00.0065
 Size: Ø 51 h 28 mm
 Volume: 11 x 92 ml Tot.: 550 ml
 Pcs/Master: 10
 EAN: 8032539930857



SF023 MUFFIN

Item: 20.023.00.0065
 Size: Ø 69 h 35 mm
 Volume: 6 x 110 ml Tot.: 660 ml
 Pcs/Master: 10
 EAN: 8032539930888



SF032 MADELEINE

Item: 20.032.00.0065
 Size: 68 x 45 h 17 mm
 Volume: 9 x 30 ml Tot.: 270 ml
 Pcs/Master: 10
 EAN: 8032539931151

**SF033 MINI CANNELE**

Item: 20.033.00.0065
 Size: Ø 35 h 35 mm
 Volume: 18 x 30 ml Tot.: 540 ml
 Pcs/Master: 10
 EAN: 8032539931182

**SF059 MIDI CANNELE**

Item: 20.059.00.0065
 Size: Ø 45 h 45 mm
 Volume: 15 x 60 ml Tot.: 900 ml
 Pcs/Master: 10
 EAN: 8032539931960

**SF050 CANNELE**

Item: 20.050.00.0065
 Size: Ø 55 h 50 mm
 Volume: 8 x 92 ml Tot.: 736 ml
 Pcs/Master: 10
 EAN: 8032539931694



SF130 MIDI BÛCHE

Item: 26.130.00.0065
Size: 84 x 32 h 35 mm
Volume: 9 x 83 ml Tot.: 747 ml
Pcs/Master: 10
EAN: 8051085049653



SF104 CUBO

Item: 26.104.00.0065
Size: 50 x 50 h 50 mm
Volume: 8 x 125 ml Tot.: 1000 ml
Pcs/Master: 10
EAN: 8051085025336



SF105 CUBO

Item: 26.105.00.0065
Size: 35 x 35 h 35 mm
Volume: 15 x 42 ml Tot.: 630 ml
Pcs/Master: 10
EAN: 8051085028658



**SF001 SEMISFERA**

Polybag: 20.001.00.0060
 Item: 20.001.00.0065
 Ø 80 h 40 mm | 5 x 120 ml Tot.: 600 ml
 Pcs/master: 10
 EAN Polybag: 8032539932431
 EAN Box: 8032539930017

**SF003 SEMISFERA**

Polybag: 20.003.00.0060
 Item: 20.003.00.0065
 Ø 60 h 30 mm | 6 x 60 ml Tot.: 360 ml
 Pcs/master: 10
 EAN Polybag: 8032539930307
 EAN Box: 8032539930284

**SF004 SEMISFERA**

Polybag: 20.004.00.0060
 Item: 20.004.00.0065
 Ø 50 h 25 mm | 8 x 30 ml Tot.: 240 ml
 Pcs/master: 10
 EAN Polybag: 8032539930338
 EAN Box: 8032539930314

**SF005 SEMISFERA**

Polybag: 20.005.00.0060
 Item: 20.005.00.0065
 Ø 40 h 20 mm | 18 x 20 ml Tot.: 300 ml
 Pcs/master: 10
 EAN Polybag: 8032539930369
 EAN Box: 8032539930345

**SF007 PIRAMIDI**

Polybag: 20.007.00.0060
 71 x 71 h 40 mm | 6 x 90 ml Tot.: 540 ml
 Pcs/master: 10
 EAN Polybag: 8032539930420

**SF008 PIRAMIDI**

Polybag: 20.008.00.0060
 36 x 36 h 22 mm | 15 x 20 ml Tot.: 300 ml
 Pcs/master: 10
 EAN Polybag: 8032539930451

**SF009 POMPONETTE**

Polybag: 20.009.00.0060
 Item: 20.009.00.0065
 Ø 34 h 16 mm | 24 x 18 ml Tot.: 432 ml
 Pcs/master: 10
 EAN Polybag: 8032539930482
 EAN Box: 8032539930468

**SF010 SAVARIN**

Polybag: 20.010.00.0060
 Item: 20.010.00.0065
 Ø 41 h 12 mm | 18 x 18 ml Tot.: 324 ml
 Pcs/master: 10
 EAN Polybag: 8032539930512
 EAN Box: 8032539930499

**SF011 SAVARIN**

Polybag: 20.011.00.0060
 Item: 20.011.00.0065
 Ø 65 h 21 mm | 8 x 50 ml Tot.: 400 ml
 Pcs/master: 10
 EAN Polybag: 8032539930543
 EAN Box: 8032539930529



SF012 SAVARIN

Polybag: 20.012.00.0060
 Item: 20.012.00.0065
 Ø 72 h 23 mm | 6 x 62 ml Tot.: 372 ml
 Pcs/master: 10
 EAN Polybag: 8032539930574
 EAN Box: 8032539930550



SF013 TARTELLETTA

Polybag: 20.013.00.0060
 Item: 20.013.00.0065
 Ø 45 h 10 mm | 15 x 20 ml Tot.: 300 ml
 Pcs/master: 10
 EAN Polybag: 8032539930604
 EAN Box: 8032539930581



SF014 TARTELLETTA

Polybag: 20.014.00.0060
 Item: 20.014.00.0065
 Ø 50 h 15 mm | 15 x 25 ml Tot.: 375 ml
 Pcs/master: 10
 EAN Polybag: 8032539930635
 EAN Box: 8032539930611



SF015 TARTELLETTA

Polybag: 20.015.00.0060
 Ø 60 h 17 mm | 8 x 40 ml Tot.: 320 ml
 Pcs/master: 10
 EAN Polybag: 8032539930666



SF016 TARTELLETTA

Polybag: 20.016.00.0060
 Item: 20.016.00.0065
 Ø 70 h 20 mm | 6 x 70 ml Tot.: 420 ml
 Pcs/master: 10
 EAN Polybag: 8032539930697
 EAN Box: 8032539930673



SF019 BABÁ

Polybag: 20.019.00.0060
 Item: 20.019.00.0065
 Ø 35 h 38 mm | 15 x 30 ml Tot.: 450 ml
 Pcs/master: 10
 EAN Polybag: 8032539930789
 EAN Box: 8032539930765



SF020 BABÁ

Polybag: 20.020.00.0060
 Ø 45 h 48 mm | 11 x 50 ml Tot.: 550 ml
 Pcs/master: 10
 EAN Polybag: 8032539930819



SF021 BABÁ

Polybag: 20.021.00.0060
 Item: 20.021.00.0065
 Ø 55 h 60 mm | 8 x 92 ml Tot.: 736 ml
 Pcs/master: 10
 EAN Polybag: 8032539930840
 EAN Box: 8032539930826



SF024 MUFFIN

Polybag: 20.024.00.0060
 Ø 81 h 32 mm | 5 x 135 ml Tot.: 675 ml
 Pcs/master: 10
 EAN Polybag: 8032539930932



SF025 FINANZIERI

Polybag: 20.025.00.0060
 Item: 20.025.00.0065
 49 x 26 h 11 mm | 20 x 20 ml Tot.: 400 ml
 Pcs/master: 10
 EAN Polybag: 8032539930963
 EAN Box: 8032539930949



SF027 PETIT-FOURS

Polybag: 20.027.00.0060
 Item: 20.027.00.0065
 Ø 40 h 20 mm | 15 x 30 ml Tot.: 450 ml
 Pcs/master: 10
 EAN Polybag: 8032539931021
 EAN Box: 8032539931007



SF028 CILINDRO

Polybag: 20.028.00.0060
 Item: 20.028.00.0065
 Ø 60 h 35 mm | 8 x 90 ml Tot.: 720 ml
 Pcs/master: 10
 EAN Polybag: 8032539931052
 EAN Box: 8032539931038



SF029 FIORENTINE

Polybag: 20.029.00.0060
 Item: 20.029.00.0065
 Ø 60 h 12 mm | 8 x 35 ml Tot.: 280 ml
 Pcs/master: 10
 EAN Polybag: 8032539931083
 EAN Box: 8032539931069



SF030 FIORENTINE

Polybag: 20.030.00.0060
 Item: 20.030.00.0065
 Ø 35 h 5 mm | 24 x 5 ml Tot.: 120 ml
 Pcs/master: 10
 EAN Polybag: 8032539931113
 EAN Box: 8032539931090



SF031 MADELEINE

Polybag: 20.031.00.0060
 Item: 20.031.00.0065
 44 x 34 h 10 mm | 15 x 10 ml Tot.: 150 ml
 Pcs/master: 10
 EAN Polybag: 8032539931144
 EAN Box: 8032539931120



SF034 BRIOCHETTE

Polybag: 20.034.00.0060
 Item: 20.034.00.0065
 Ø 79 h 37 mm | 6 x 110 ml Tot.: 660 ml
 Pcs/master: 10
 EAN Polybag: 8032539931236
 EAN Box: 8032539931212



SF035 BRIOCHETTE

Polybag: 20.035.00.0060
 Item: 20.035.00.0065
 Ø 79 h 30 mm | 6 x 110 ml Tot.: 660 ml
 Pcs/master: 10
 EAN Polybag: 8032539931267
 EAN Box: 8032539931243



SF039 BARCHETTA

Polybag: 20.039.00.0060
 Item: 20.039.00.0065
 100 x 44 h 15 mm | 9 x 40 ml Tot.: 360 ml
 Pcs/master: 10
 EAN Polybag: 8032539931380
 EAN Box: 8032539931366



SF041 MEZZO UOVO

Polybag: 20.041.00.0060
 Item: 20.041.00.0065
 102 x 73 h 36 mm | 650 x 130 ml Tot.: 650 ml
 Pcs/master: 10
 EAN Polybag: 8032539931441
 EAN Box: 8032539931427



SF043 TORTINA

Polybag: 20.043.00.0060
 Item: 20.043.00.0065
 Ø 40 h 13 mm | 15 x 20 ml Tot.: 300 ml
 Pcs/master: 10
 EAN Polybag: 8032539931502
 EAN Box: 8032539931489



SF047 TORTINA

Polybag: 20.047.00.0060
 Item: 20.047.00.0065
 Ø 80 h 18 mm | 6 x 72 ml Tot.: 432 ml
 Pcs/master: 10
 EAN Polybag: 8032539931625
 EAN Box: 8032539931601



SF048 DIAMANTE

Polybag: 20.048.00.0060
 Item: 20.048.00.0065
 Ø 35 h 23 mm | 360 x 20 ml Tot.: 360 ml
 Pcs/master: 10
 EAN Polybag: 8032539931656
 EAN Box: 8032539931632



SF051 BAVARESE

Polybag: 20.051.00.0060
 Ø 57 h 57 mm | 8 x 130 ml Tot.: 1040 ml
 Pcs/master Polybag: 10
 EAN Polybag: 8032539931748



SF052 MUFFIN

Polybag: 20.052.00.0060
 Item: 20.052.00.0065
 Ø 75 h 60 mm | 6 x 165 ml Tot.: 990 ml
 Pcs/master: 10
 EAN Polybag: 8032539931779
 EAN Box: 8032539931755



SF054 FINANZIERI

Polybag: 20.054.00.0060
 Item: 20.054.00.0065
 95 x 45 h 12 mm | 7 x 50 ml Tot.: 350 ml
 Pcs/master: 10
 EAN Polybag: 8032539931830
 EAN Box: 8032539931816



SF056 MARGHERITA

Polybag: 20.056.00.0060
 Item: 20.056.00.0065
 Ø 70 h 28 mm | 6 x 80 ml Tot.: 480 ml
 Pcs/master: 10
 EAN Polybag: 8032539931892
 EAN Box: 8032539931878



SF057 GUGELHOPF

Polybag: 20.057.00.0060
 Ø 55 h 36 mm | 8 x 50 ml Tot.: 400 ml
 Pcs/master: 10
 EAN Polybag: 8032539931922

**SF061 FANTASY**

Polybag: 20.061.00.0060
 Item: 20.061.00.0065
 Ø 75 h 40 mm | 6 x 100 ml Tot.: 600 ml
 Pcs/master Polybag: 10
 EAN Polybag: 8032539932592
 EAN Box: 8051085020423

**SF098 CILINDRO**

Polybag: 20.098.00.0060
 Item: 20.098.00.0065
 Ø 48 h 50 mm | 12 x 83 ml Tot.: 996 ml
 Pcs/master: 10
 EAN Polybag: 8051085022359
 EAN Box: 8051085052028

**SF102 MEDIUM MUFFIN**

Polybag: 26.102.00.0060
 Item: 26.102.00.0065
 Ø 68 h 38 mm | 5 x 119 ml Tot.: 714 ml
 Pcs/master: 10
 EAN Polybag: 8051085023417
 EAN Box: 8051085145706

**SF103 SAVOJARDO**

Polybag: 26.103.00.0060
 Item: 26.103.00.0065
 127 x 47 h 17 mm | 6 x 84 ml Tot.: 504 ml
 Pcs/master: 10
 EAN Polybag: 8051085021987
 EAN Box: 8032539930925

**SF104 CUBI**

Polybag: 26.104.00.0060
 Item: 26.104.00.0065
 50 x 50 h 50 mm | 8 x 125 ml Tot.: 1000 ml
 Pcs/master: 10
 EAN Polybag: 8051085023424
 EAN Box: 8051085025336

**SF109 MINI BRIOCHETTE**

Polybag: 26.109.00.0060
 Item: 26.109.00.0065
 Ø 58 h 22 mm | 12 x 33 ml Tot.: 396 ml
 Pcs/master: 10
 EAN Polybag: 8051085023486
 EAN Box: 8051085025718

**SF110 RETTANGOLO**

Polybag: 26.110.00.0060
 Item: 26.110.00.0065
 87 x 48 h 24 mm | 7 x 97 ml Tot.: 679 ml
 Pcs/master: 10
 EAN Polybag: 8051085030392
 EAN Box: 8051085029099

**SF119 CYLINDERS**

Polybag: 26.119.00.0060
 Item: 26.119.00.0065
 Ø 63 h 40 mm | 8 x 123 ml Tot.: 984 ml
 Pcs/master: 10
 EAN Polybag: 8051085049424
 EAN Box: 8051085049448

**SF127 CYLINDERS**

Polybag: 26.127.00.0060
 Item: 26.127.00.0065
 Ø 70 h 35 mm | 6 x 133 ml Tot.: 798 ml
 Pcs/master: 10
 EAN Polybag: 8051085049554
 EAN Box: 8051085049578



SF129 MINI BUCHE

Item: 26.129.00.0065
44 x 18 h 20 mm | 30 x 14 ml Tot.: 420 ml
EAN: 8051085049615

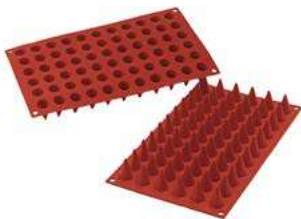

SF131 CONO

Polybag: 26.131.00.0060
Item: 26.131.00.0065
Ø 18 h 30 mm | 66 x 33 ml Tot.: 2178 ml
Pcs/master Polybag: 10
EAN Polybag: 8051085049677
EAN: 8051085049691



SF154 CHARLOTTE

Item: 26.154.00.0060
Ø 70 h 41 mm | 8 x 102 ml Tot.: 816 ml
EAN: 8051085170968



SF155 WAFFEL CLASSIC

Polybag: 26.155.00.0060
Item: 26.155.00.0065
130 x 81 h 17 mm | 4 x 137 ml Tot.: 548 ml
Pcs/master Polybag: 10
EAN Polybag: 8051085170845
EAN: 8051085170821



SF176 NIGIRI

Item: 26.176.00.0065
60 x 30 h 26 mm | 16 x 28 ml Tot.: 448 ml
EAN: 8051085252022



SF232 MINI GUGELHOPF

Polybag: 26.232.00.0060
Item: 26.232.00.0065
Ø 35 h 20 mm | 24 x 10 ml Tot.: 240 ml
Pcs/master Polybag: 10
EAN Polybag: 8051085287383
EAN: 8051085287413

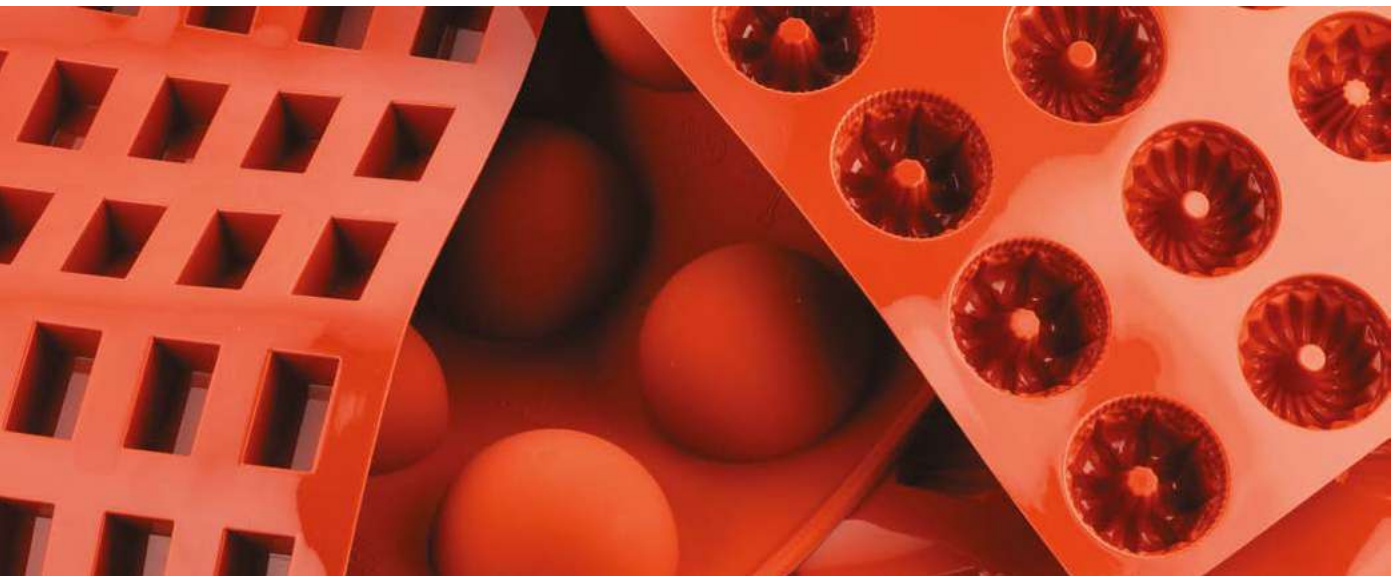

SFT118 STAMPO ROTONDO

Polybag: 20.118.00.0060
 Size: Ø 180 h 40 mm
 Volume: 1000 ml
 Pcs/Master: 6
 EAN Polybag: 8032539930024

SFT122 STAMPO ROTONDO

Polybag: 20.122.00.0060
 Size: Ø 220 h 42 mm
 Volume: 1400 ml
 Pcs/Master: 6
 EAN Polybag: 8032539930048

SFT126 STAMPO ROTONDO

Item: 20.126.00.0060
 Size: Ø 260 h 45 mm
 Volume: 2200 ml
 Pcs/Master: 6
 EAN Polybag: 8032539930062

**SFT226 STAMPO ROTONDO
+ ANELLO**

Polybag: 20.226.00.0060
 Size: Ø 260 h 55 mm
 Volume: 2500 ml
 Pcs/Master: 6
 EAN Polybag: 8032539934510

SFT120 STAMPO ROTONDO

Polybag: 20.120.00.0060
 Size: Ø 200 h 40 mm
 Volume: 1050 ml
 Pcs/Master: 6
 EAN Polybag: 8032539930031

SFT124 STAMPO ROTONDO

Polybag: 20.124.00.0060
 Size: Ø 240 h 42 mm
 Volume: 1700 ml
 Pcs/Master: 6
 EAN Polybag: 8032539930055

SFT128 STAMPO ROTONDO

Polybag: 20.128.00.0060
 Size: Ø 280 h 47 mm
 Volume: 2500 ml
 Pcs/Master: 6
 EAN Polybag: 8032539930079

**SFT424 CROSTATA**

Polybag: 20.424.00.0060
 Size: Ø 240 h 30 mm
 Volume: 1250 ml
 Pcs/Master: 6
 EAN Polybag: 8032539930208

SFT428 CROSTATA

Polybag: 20.428.00.0060
 Size: Ø 280 h 30 mm
 Volume: 1750 ml
 Pcs/Master: 6
 EAN Polybag: 8032539930222



SFT326 PLUM CAKE

Polybag: 20.326.00.0060
Size: 240 x 110 h 65 mm
Volume: 1500 ml
Pcs/Master: 6
EAN Polybag: 8032539930192



SFT331 PLUM CAKE

Polybag: 20.331.00.0060
Size: 300 x 100 h 70 mm
Volume: 1700 ml
Pcs/Master: 6
EAN Polybag: 8032539934534

SFT205 CIAMBELLA

Polybag: 20.205.00.0060
Size: Ø 240 h 55 mm
Volume: 1500 ml
Pcs/Master: 6
EAN Polybag: 8032539934503

SFT224 CIAMBELLA + ANELLO

Polybag: 20.224.00.0060
Size: Ø 240 h 55 mm
Volume: 1300 ml
Pcs/Master: 6
EAN Polybag: 8032539930147



**SFT228 PIZZA**

Polybag: 20.228.00.0060
 Size: Ø 280 h 20 mm
 Volume: 1300 ml
 Pcs/Master: 6
 EAN Polybag: 8032539930154

**SFT522 BRIOCHE**

Polybag: 20.522.00.0060
 Size: Ø 220 h 80 mm
 Volume: 1700 ml
 Pcs/Master: 4
 EAN Polybag: 8032539932745

**SFT332 LASAGNERA**

Polybag: 20.332.00.0060
 Size: 330 x 220 h 55 mm
 Volume: 4500 ml
 Pcs/Master: 4
 EAN Polybag: 8032539934541

**SFT220 MARGHERITA**

Polybag: 20.220.00.0060
 Size: Ø 220 h 45 mm
 Volume: 1300 ml
 Pcs/Master: 6
 EAN Polybag: 8032539930130

**SFT300 RETTANGOLARE**

Polybag: 20.300.00.0060
 Size: 280 x 220 h 40 mm
 Volume: 2250 ml
 Pcs/Master: 6
 EAN Polybag: 8032539930178

**SFT306 QUADRATO**

Polybag: 20.306.00.0060
 Size: 228 x 228 h 50 mm
 Volume: 2300 ml
 Pcs/Master: 5
 EAN Polybag: 8032539934527

SILICOPAT 1

Item: 23.001.00.0062
Size: 400 x 600 mm
Pcs/Master: 4
EAN: 8032539933681

SILICOPAT 6

Item: 23.006.00.0062
Size: 360 x 430 mm
Pcs/Master: 4
EAN: 8032539933704

SILICOPAT 8

Item: 23.008.00.0062
Size: 250 x 350 mm
Pcs/Master: 4
EAN: 8032539933728



SILICOPAT 5

Item: 23.005.00.0062
Size: 270 x 420 mm
Pcs/Master: 4
EAN: 8032539933698

SILICOPAT 7

Item: 23.007.00.0062
Size: 300 x 400 mm
Pcs/Master: 4
EAN: 8032539933711

TAPIS ROULADE

Item: 23.022.00.0065
Size: 325 x 325 h 10 mm
Pcs/Master: 3
EAN: 8051085252251



CUP01 - SET 6 PIROTTINI

Item: 25.420.01.0165
Size: Ø 68 h 32 mm
Pcs/master: 6
EAN: 8051085233625



MAC01 - MACARONS

Item: 23.041.00.0065
 Size: Ø 35 - 300 x 400 mm
 Pcs/master: 6
 EAN: 8051085235810

**MAC03 - HEART**

Item: 23.043.00.0065
 Size: 38 x 35 - 300 x 400 mm
 Pcs/master: 6
 EAN: 8051085235841

**FIBERGLASS 5**

Item: 70.626.87.0065
 Size: 400 x 300 mm
 Pcs/master: 6
 EAN: 8051085251469

**MACARON FIBERGLASS 30X40**

Item: 70.114.00.0065
 Size: 400 x 300
 Pcs/Master: 6
 EAN: 8051085368617



AIR MAT

Item: 70.109.99.0065

Size: 400 x 300 mm

Pcs/master: 6

EAN: 8051085252220



Modo d'uso: *How to use:* | *Mode d'emploi:*



ÉCLAIR & CHOUX MAT

Item: 70.113.00.0065
 Size: 300 x 400 mm
 Size choux small: Ø 30 mm
 Size éclair regular: 120 x 25 mm
 Pcs/Master: 6
 EAN: 8051085324194



Prova con | Try it with: | Essayer avec:



AIRPLUS®



AIRPLUS®

UNA COTTURA RIVOLUZIONARIA • A REVOLUTIONARY BAKING • UNE CUISSON RÉVOLUTIONNAIRE

NUOVI STAMPI MICROFORATI

Nuovi stampi microforati in fibra di vetro ideali per la cottura. Questi innovativi stampi grazie alla loro trama microforata consentono una diffusione uniforme del calore, riducendo i tempi di cottura e garantendo un risultato perfetto. Ideali sia per creazioni dolci che salate. Sono ideali per creare crostate, prodotti lievitati e sfoglie. Gli stampi sono antiaderenti e possono essere utilizzati su entrambi i lati per preparare tartellette vuote o ripiene. Range di temperatura: - 40 ° C + 230 ° C.

NEW MICRO-PERFORATED MOLDS

New micro-perforated silicone molds with a glass fiber ideal for baking. These innovative molds thanks to their micro-perforated texture allow a uniform diffusion of the reducing cooking times and ensuring a perfect result. Perfect both for sweet and savory creations. They are ideal for create tarts, leavened products, short pastry and crust. The moulds are non-stick and can be used on both sides to prepare empty or stuffed tartlets. Temperature range: -40°F +446°F.

NOUVEAUX MOULES MICROFORÉS

Nouveaux moules en silicone perforée en fibre de verre, idéaux pour la cuisson. Grâce à leur texture microperforée, ces moules innovants permettent une diffusion uniforme de la chaleur, réduisant les temps de cuisson et garantissant un résultat parfait pour vos créations sucrées et salées. Ils sont parfaits pour préparer des tartes, des produits au levain et des viennoiseries. Les moules sont antiadhésifs et peuvent être utilisés des deux côtés pour préparer des tartelettes vides ou fourrées. Ils résistent parfaitement à une amplitude de -40°C à +230°C.



Ideali per tutti i tipi di impasto, texture e consistenze: dalle masse montate ai lievitati sfogliati, alle paste friabili.

Ideal for all kind of batters, pastries and doughs: perfect for sponge cakes, shortcrust, flaky textures, puff pastry and yeasted dough.

Idéaux pour toutes sortes de pâtes et textures: montées, feuilletées et sablées.



L'impasto rimane contenuto nella cavità dello stampo microforato e non fuoriesce.

The dough remains inside the micro-perforated mould cavity and does not leak out.

La pâte reste bien à l'intérieure de la cavité du moule micro-perforé.



Stampo antiaderente.

Non stick mould.

Moule anti-adhésif.



Smodellamento semplice e perfetto.

Easy and perfect unrolling.

Démoulage facile et parfait.



Stampo utilizzabile su entrambi i lati per preparare gusci di pasta frolla o pasta brisée e tartellette ripiene.

The mould can be used on both sides to prepare shortcrust pastry or brisée pastry shells and stuffed tartlets.

Moule utilisable des deux côtés pour préparer des coques de pâte sablée ou de pâte brisée et des tartelettes farcies.

AIRPLUS 02 PLUM CAKE

Item: 70.502.20.0265
 Mould size: 195 x 290 mm
 Cavity size: 270 x 70 h 30 mm
 Set: 2 pcs
 Pcs/Master: 10
 EAN: 8051085326235

**AIRPLUS 03 MINI PLUMCAKE**

Item: 70.503.20.0265
 Mould size: 195 x 290 mm
 Cavity size: 40 x 95 h 25 mm
 Set: 2 pcs
 Pcs/Master: 10
 EAN: 8051085326259

**AIRPLUS 13 ROUND**

Item: 70.513.20.0065
 Mould size: 300 x 400 mm
 Cavity size: Ø 60 h 40 mm
 Set: 1 pc
 Pcs/Master: 5
 EAN: 8051085325696

**AIRPLUS 14 ROUND**

Item: 70.514.20.0065
 Mould size: 300 x 400 mm
 Cavity size: Ø 85 h 20 mm
 Set: 1 pc
 Pcs/Master: 5
 EAN: 8051085325719



AIRPLUS 15 ROUND

Item: 70.515.20.0065
 Mould size: 300 x 400 mm
 Cavity size: Ø 40 h 16 mm
 Set: 1 pc
 Pcs/Master: 5
 EAN: 8051085325832

**AIRPLUS 16 ROUND**

Item: 70.516.20.0065
 Mould size: 300 x 400 mm
 Cavity size: Ø 50 h 16 mm
 Set: 1 pc
 Pcs/Master: 5
 EAN: 8051085325900

**AIRPLUS 18 ROUND**

Item: 70.518.20.0065
 Mould size: 300 x 400 mm
 Cavity size: Ø 48 h 22 mm
 Set: 1 pc
 Pcs/Master: 5
 EAN: 8051085325849

**AIRPLUS 12 ROUND**

Item: 70.512.20.0065
 Mould size: 300 x 400 mm
 Cavity size: Ø 120 h 30 mm
 Set: 1 pc
 Pcs/Master: 5
 EAN: 8051085325894



AIRPLUS 17 SQUARE

Item: 70.517.20.0065
 Mould size: 300 x 400 mm
 Cavity size: 50 x 50 h 20 mm
 Set: 1 pc
 Pcs/Master: 5
 EAN: 8051085325856

**AIRPLUS 19 SQUARE**

Item: 70.519.20.0065
 Mould size: 300 x 400 mm
 Cavity size: 85 x 85 h 20 mm
 Set: 1 pc
 Pcs/Master: 5
 EAN: 8051085325863

**AIRPLUS 20 SQUARE**

Item: 70.520.20.0065
 Mould size: 300 x 400 mm
 Cavity size: 35 x 35 h 16 mm
 Set: 1 pc
 Pcs/Master: 5
 EAN: 8051085325870

**AIRPLUS 21 TRIANGLE**

Item: 70.521.20.0065
 Mould size: 300 x 400 mm
 Cavity size: 60 x 60 x 60 h 25 mm
 Set: 1 pc
 Pcs/Master: 5
 EAN: 8051085326136



AIRPLUS 11 ÉCLAIR

Item: 70.511.20.0065

Mould size: 300 x 400 mm

Cavity size: 25 x 125 h 5 mm

Set: 1 pc

Pcs/Master: 5

EAN: 8051085326150



WINTER HOLIDAY INSPIRATION





CA01 CREATIVE XMAS COUNTDOWN

Silicone mould + Gift Box
 Item: 25.741.63.0060
 Size: 28 x 28 h 13 mm
 Volume: 140 ml
 Pcs/Master: 10
 EAN: 8051085217373



GIFT BOX CREATIVE XMAS COUNTDOWN

Set 2 Pcs Gift Box
 Item: 22.741.00.0061
 Pcs/Master: 6
 EAN: 8051085217397



SET DECORATIVE SPOON + CUP

Item: 70.131.98.0067
 Pcs/master: 12
 EAN: 8051085243822



CUP DECORATIVE SPOON

Item: 70.140.99.0067
 Pcs/master: 24
 EAN: 8051085243853



ACC099 DECORATIVE SPOON

Item: 70.131.99.0067
 Pcs/master: 12
 EAN: 8051085175277





SF TREE CHOC

Item: 22.151.77.0065
 Size: Ø 130 h 172 mm
 Volume Tot.: 96 ml
 Pcs/Master: 3
 EAN: 8051085044337



TAPIS ROULADE

Item: 23.022.00.0065
 Size: 325 x 325 h 10 mm
 Pcs/Master: 3
 EAN: 8051085252251



SF100 MINI PANDORO

Item: 26.100.00.0065
 Size: 75 x 75 h 60 mm
 Volume: 6 x 150 ml Tot.: 900 ml
 Pcs/Master: 10
 EAN: 8051085339822



SF108 PINO

Item: 26.108.00.0065
 Size: 83 x 68 h 30 mm
 Volume: 8 x 81 ml Tot.: 648 ml
 Pcs/master: 10
 EAN: 8051085053100



SF166 MAGIC XMAS

Item: 26.166.63.0063
 Size: 50 x 34 h 21 mm
 Volume: 15 x 22 ml Tot.: 334 ml
 Pcs/master: 3
 EAN: 8051085252916



SF107 STELLA

Item: 26.107.00.0063
 Size: Ø 70 h 25 mm
 Volume: 8 x 70 ml Tot.: 420 ml
 Pcs/master: 10
 EAN: 8051085346424





SF106 GINGERBREAD MAN

Item: 26.106.00.0065
 Size: 94 x 78 h 21 mm
 Volume: 6 x 60 ml Tot.:360 ml
 Pcs/master: 10
 EAN: 8051085342228



SF201 IGLOO

Item: 26.201.87.0065
 Size: Ø 38 h 42mm
 Volume: 6 x 115 ml Tot.: 690 ml
 Pcs/master: 10
 EAN: 8051085359738



SFT203 CHRISTMAS TREE

Item: 20.203.63.0065
 Size: 280 x 200 h 40 mm
 Volume: 1000 ml
 Pcs/master: 3
 EAN: 8051085321605



SFT201 ETOLIE

Item: 20.201.63.0063
 Size: Ø 260 h 40 mm
 Volume: 1200 ml
 Pcs/master: 4
 EAN: 8051085252534



ACC079 STAR

Item: 70.100.05.0060
 Size: 100 x 100 h 25 mm
 Pcs/master: 12
 EAN: 8051085011247



ACC097 SNOW MAN

Item: 70.100.07.0060
 Size: 115 x 73 h 25 mm
 Pcs/master: 12
 EAN: 8051085048779

TI POTREBBE PIACERE ANCHE:***YOU MIGHT ALSO LIKE:******VOUS POURRIEZ ÉGALEMENT AIMER :***

ABBRACCIO	24
ARTIC	48
BÛCHE QUENELLE	48
BÛCHE SAPIN	47
CKC01 SNOWMAN SLIM	139
CKC02 COOKIE XMAS SLIM	139
COCCOLA	39
CORALLO	49
DIAMOND BÛCHE	50
DOLCE TARTUFO	39
FROZEN BÛCHE	51
FROZEN BÛCHE MAT	53
GEL01M MINI CLASSIC	185
INTRECCIO	21
KIT ICE GLOW	49
KIT MAGIC WOOD	52
KIT MINI TARTE TWIST	63
KIT TARTE GRAPHIQUE	60
KIT TARTE MERINGUÉ	61
LANA	48
MAGIC BÛCHE	51
MAGIC BÛCHE MAT	52
MERINGA	49
MIDI BUCHE	148
MINI INTRECCIO	38
MINI RAGGIO	39
MOSAICO	41
QUADRO	20
SCG054 CHOCO TREES	127
SCG056 MR & MRS BROWN	127
SCG06 CHRISTMAS	132
SCG12 MR GINGER	132
SCG23 CHOCO WINTER	134
SCG40 CHOCO FROZEN	136
SCG41 XMAS CHOCO BUTTONS	137
SCG45 WINTER STARS	137
SCG46 CHOCO PINE	137
SCG49 3D CHOCO CROWN	129
SOFFICE INCANTO	40
STARLIGHT BÛCHE	51
TAPIS ROULADE	158
VINILE	20
VOILÀ COOKIE - WINTER HOLIDAY	68
WINTER VILLAGE	47



CELEBRATION





FREE BAKE

Item: 25.982.85.0065
 Size: 1070 x 55 h 95 mm
 Pcs/Master: 6
 EAN: 8051085244478



DONUTS

Item: 26.170.00.0065
 Size: Ø 75 h 28 mm
 Volume: 6 x 98 ml Tot.: 588 ml
 Pcs/Master: 10
 EAN: 8051085334018



SMALL DONUTS

Item: 26.171.00.0065
 Size: Ø 45 h 18 mm
 Volume: 15 x 22 ml Tot.: 330 ml
 Pcs/Master: 10
 EAN: 8051085336845

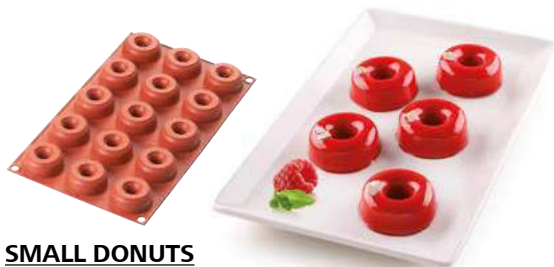

SF061 FANTASY

Item: 20.061.00.0065
 Size: Ø 75 h 40 mm
 Volume: 6 x 100 ml Tot.: 600 ml
 Pcs/master: 10
 EAN: 8051085020423





SF132 MINI FANTASY

Item: 26.132.00.0065
 Size: Ø 40 h 22 mm
 Volume: 18 x 17,5 ml Tot.: 315 ml
 Pcs/master: 10
 EAN: 8051085355686



SF077 ROSE

Item: 20.077.00.0065
 Size: Ø 76 h 40 mm
 Volume: 6 x 115 ml Tot.: 690 ml
 Pcs/master: 10
 EAN: 8051085342037



SF074 SMALL ROSE

Item: 20.074.00.0065
 Size: Ø 44 h 27 mm
 Volume: 15 x 23 ml Tot.: 345 ml
 Pcs/master: 10
 EAN: 8051085342068



SF076 SUNFLOWER

Item: 20.076.00.0065
 Size: Ø 76 h 40 mm
 Volume: 6 x 115 ml vol Tot.: 690 ml
 Pcs/master: 10
 EAN: 8051085355877



SF117 SPRINGLIFE

Item: 26.117.00.0065
 Size: Ø 69 h 32 mm
 Volume: 8 x 80 ml Tot.: 646 ml
 Pcs/master: 10
 EAN: 8051085365753



SF135 MINI SPRINGLIFE

Item: 26.135.85.0065
 Size: Ø 43 h 20 mm
 Volume: 15 x 20 ml Tot.: 305 ml
 Pcs/master: 10
 EAN: 8051085315369



SF118 TULIP

Item: 26.118.05.0063
 Size: 76 x 50 h 29 mm
 Volume: 8 x 62 ml Tot.: 500 ml
 Pcs/master: 3
 EAN: 8051085024445



SF155 WAFFEL

Item: 26.155.00.0065
 Size: 130 x 81 h 17 mm
 Volume: 4 x 137 ml Tot.: 548 ml
 Pcs/master: 10
 EAN: 8051085170821



SF154 CHARLOTTE

Item: 26.154.76.0065
 Size: Ø 70 h 41 mm
 Volume: 8 x 102 ml Tot.: 816 ml
 Pcs/master: 10
 EAN: 8051085309153



SF158 MINI VERTIGO

Item: 26.158.00.0065
 Size: Ø 78 h 37 mm
 Volume: 6 x 110 ml Tot.: 660 ml
 Pcs/master: 10
 EAN: 8051085192052



SFT600 METEOR

Item: 24.600.00.0065
 Size: Ø 240 h 100 mm
 Volume: 2,3 L
 Pcs/master: 6
 EAN: 8051085375738



SFT251 ROSE

Item: 24.251.00.0065
 Size: Ø 220 h 100 mm
 Volume: 2,2 L
 Pcs/master: 6
 EAN: 8051085342105





SFT252 GIRASOLE

Item: 24.252.00.0065
 Size: Ø 260 h 70 mm
 Volume: 2,2 L
 Pcs/master: 3
 EAN: 8051085358953



SFT303 CATHEDRAL

Item: 24.303.00.0065
 Size: Ø 220 h 100 mm
 Volume: 2,2 L
 Pcs/master: 6
 EAN: 8051085357949



SFT211 LOVE

Item: 20.211.00.0065
 Size: 205 x 186 h 54 mm
 Volume: 1,1 L
 Pcs/master: 6
 EAN: 8051085368037



SFT GOLEADOR

Item: 20.339.00.0065
 Size: 242 x 230 h 40 mm
 Volume: 1,2 L
 Pcs/master: 6
 EAN: 8051085355853



SFT336 FAIRY PRINCESS

Item: 20.336.00.0065
 Size: 28,5 x 14,5 h 40 mm
 Volume: 950 ml
 Pcs/master: 10
 EAN: 8051085356485



DIVA

Item: 26.266.13.0065
 Size: 130 x 74 h 28 mm
 Volume: 4 x 180 ml Tot.: 720 ml
 Pcs/master: 10
 EAN: 8051085301980



EASY ICE CREAM





ROUND 3D

NEW

Set 2 pcs

Item: 25.359.87.0065

Size: Ø 70 h 23 mm

Volume: 4 x 82 ml Tot.: 328 ml

Pcs/Master: 6

EAN: 8051085380411

x2 Pcs



+ 50 Sticks



CLASSIC 3D

Set 2 pcs

Item: 25.354.87.0065

Size: 43 x 93 h 25 mm

Volume: 2 x 76 ml Tot.: 152 ml

Pcs/Master: 3

EAN: 8051085365937

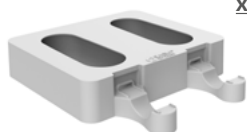

x2 Pcs

+ 50 Sticks





x2 Pcs



+ 50 Sticks



SET GEL01 CLASSIC

Set 2 Pcs
Item: 25.321.87.0065
Size: 93 x 48 h 25 mm
Volume: 180 ml
Pcs/master: 3
EAN: 8051085150342



x2 Pcs



+ 50 Sticks



SET GEL03 HEART-IC

Set 2 Pcs
Item: 25.323.87.0065
Size: 91 x 85 h 23 mm
Volume: 192 ml
Pcs/master: 3
EAN: 8051085150335



x2 Pcs



+ 50 Sticks



SET GEL02 CHOCOSTICK

Set 2 Pcs
Item: 25.322.87.0065
Size: 92 x 48 h 24 mm
Volume: 180 ml
Pcs/master: 3
EAN: 8051085150328



x2 Pcs



+ 50 Sticks



SET GEL04 TANGO

Set 2 Pcs
Item: 25.324.87.0065
Size: 92 x 45 h 27,5 mm
Volume: 180 ml
Pcs/master: 3
EAN: 8051085049240



BASTONCINI

Set 100 Pcs
Item: 99.400.99.0002
Size: 113 x 10 h 2 mm
Pcs/master: 10
EAN: 8032539930802





GEL01M MINI CLASSIC

Item: 22.341.87.0065
 Size: 73 x 38 h 18 mm
 Volume: 148 ml
 Pcs/master: 30
 EAN: 8051085063710



+ 50 Sticks



GEL03M MINI HEART-IC

Item: 22.343.87.0065
 Size: 67 x 55 h 18 mm
 Volume: 135 ml
 Pcs/master: 30
 EAN: 8051085063833



+ 50 Sticks



GEL10M MINI VINTAGE

Item: 22.350.87.0065
 Size: 93 x 48 h 180 mm
 Volume: 180 ml
 Pcs/master: 30
 EAN: 8051085295319



+ 50 Sticks



GEL04M MINI TANGO

Item: 22.344.87.0065
 Size: 67 x 33 h 22 mm
 Volume: 144 ml
 Pcs/master: 30



+ 50 Sticks



EAN: 8051085063734



GEL05M MINI CHIC

Item: 22.345.87.0065
 Size: 70 x 33 h 22 mm
 Volume: 152 ml
 Pcs/master: 30
 EAN: 8051085063741



+ 50 Sticks



BASTONCINI MINI

Set 100 Pcs
 Item: 99.401.99.0002
 Size: 72 x 8 h 2 mm
 Pcs/master: 10
 EAN: 8051085048908

ICE LOLLY

Set 3 Pcs
 Item: 25.430.99.0165
 Size: Ø 41 h 200 mm
 Volume: 216 ml
 Pcs/Master: 3
 EAN: 8051085199259

**SET STIKS EASYPOP**

Item: 99.411.99.0001
 Size: Ø 3,8 h 120 mm
 Pcs/Master: 10
 EAN: 8051085045662

Item: 99.412.99.0001
 Size: Ø 3,8 h 152 mm
 Pcs/Master: 10
 EAN: 8051085279258



Item: 99.413.99.0001
 Size: Ø 3,8 h 228 mm
 Pcs/Master: 5
 EAN: 8051085279289

POPS STAND

Color: White
 Item: 25.939.87.0065
 Size: Ø 225,5 h 110 mm
 Pcs/Master: 3
 EAN: 805108522933

Color: Black
 Item: 25.939.20.0065
 Size: Ø 225,5 h 110 mm
 Pcs/Master: 3
 EAN: 805108522964



ESPOGEL UP MINI

Color: Green
 Item: 99.432.62.0065
 Size: 360 x 235 h 50 mm
 Pcs/Master: 1
 EAN: 8051085159116

Color: Transparent
 Item: 99.432.86.0165
 Size: 360 x 235 h 50 mm
 Pcs/Master: 5
 EAN: 8051085241361

**SMALL TOTAL I-GLOO****Set VGEL03 + Coperchio**

Color: White
 Item: 25.426.87.0098
 Size: 390 x 109 h 32 mm
 Pcs/Master: 6
 EAN: 8051085146673

Color: Black
 Item: 25.426.20.0098
 Size: 390 x 109 h 32 mm
 Pcs/Master: 6
 EAN: 8051085146642

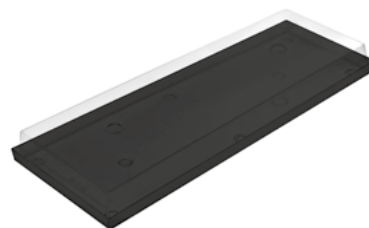
**VGEL03 Set 2 Pcs**

Color: White
 Item: 25.425.87.0098
 Size: 119 x 395,5 h 13 mm
 Pcs/Master: 20
 EAN: 8051085048472

Color: Black
 Item: 25.425.20.0098
 Size: 119 x 395,5 h 13 mm
 Pcs/Master: 20
 EAN: 8051085048410



SNACKS & CO.



SNACKS & CO.

Il piacere di creare con le proprie mani, di scegliere con cura le materie prime, di preparare piatti genuini per se stessi e per i propri cari.

La linea Snacks & Co. di Silikomart ti permette di realizzare impasti dolci e salati senza preoccuparti della forma del risultato finale, garantendo una forma perfetta a ogni utilizzo grazie alla trama microforata che permette una cottura omogenea e senza condensa.

The pleasure of creating with your own hands, of carefully choosing raw materials, of preparing genuine dishes for yourself and your loved ones.

Silikomart's Snacks & Co. range allows you to make sweet and savoury doughs without worrying about the shape of the end result, guaranteeing a perfect shape every time you use them thanks to the micro-perforated weave that allows homogeneous cooking without condensation.

Le plaisir de créer de ses propres mains, de choisir soigneusement les matières premières, de préparer des plats authentiques pour soi et ses proches.

La ligne Snacks & Co. de Silikomart permet de réaliser des pâtes sucrées et salées sans se soucier de la forme du résultat final, en garantissant une forme parfaite à chaque utilisation grâce à la trame micro-perforée qui permet une cuisson homogène sans condensation.



BURGER BREAD

Item: 21.001.13.0065

Size: Ø 80 h 20 mm

Pcs/Master: 7

EAN: 8051085296927



Texture forata
Perforated pattern
Texture perforée



MINI BAGUETTE BREAD

Item: 21.002.13.0065

Size: 170 x 55 h 20 mm

Pcs/Master: 7

EAN: 8051085296941



Texture forata
Perforated pattern
Texture perforée



FOCACCIA BREAD

Item: 21.003.13.0065

Size: 375 x 295 h 30 mm

Pcs/Master: 5

EAN: 8051085296965



Texture forata
Perforated pattern
Texture perforée



SANDWICH BREAD

Item: 21.004.13.0065
 Size: 150 x 100 h 75 mm
 Pcs/Master: 4
 EAN: 8051085296521



Texture forata
 Perforated pattern
 Texture perforée

**TRECCIA**

Item: 20.340.13.0065
 Size: 288 x 156 h 83 mm
 Volume: 2100 ml
 Pcs/Master: 3
 EAN: 8051085279517



BAKE'N ROLL

Item: 72.411.76.0065
Size: 110 x 97 h 78 mm
Pcs/Master: 4
EAN: 8051085295524



SNACK'N ROLL

Item: 72.412.85.0065
Size: 110 x 97 h 78 mm
Pcs/Master: 4
EAN: 8051085295616



SURPRISE

Item: 72.401.61.0065

Size: 75 x 50 mm

Pcs/Master: 6

EAN: 8051085292073

+ 80 Foglietti

+ 80 Sheets

+ 80 Papiers

**FOR YOU**

Item: 72.402.61.0065

Size: 76 x 72 mm

Pcs/Master: 6

EAN: 8051085292097

+ 80 Foglietti

+ 80 Sheets

+ 80 Papiers



CAKE DESIGN



CAKE DESIGN

Fantasia, ricerca nel design e creatività: tre parole che esprimono perfettamente il mondo del cake design. Qui troverai tutti i prodotti dedicati al mondo del cake design per decorare le tue torte a piani e da cerimonia. Per raggiungere la perfezione, è la qualità a fare la differenza. Scegli il tuo stile, libera la tua immaginazione e crea la tua opera d'arte culinaria.

Imagination, design research and creativity: three words which perfectly express the world of cake design.

Here you will find all the products dedicated to the world of cake design to decorate your monumental and ceremonial cakes. In order to achieve perfection, quality makes all the difference. Choose your style, free your imagination and create your own culinary work of art.

Imagination, design et créativité : trois mots qui expriment parfaitement le monde du cake design. Ici vous trouverez tous les produits dédiés au monde du cake design pour décorer vos gâteaux à étages et de cérémonie. Pour atteindre la perfection, c'est la qualité qui fait la différence. Choisissez votre style, libérez votre imagination et créez votre œuvre d'art culinaire.

WONDER POPS

Item: 25.321.87.0165
 Size: Ø 30 mm
 Volume: 224 ml
 Pcs/Master: 6
 EAN: 8051085340200

+36 Sticks



EC03 SWEET TREATS

GIFT BOX - Item: 22.753.35.0069 | EAN: 8051085192632
 Volume: 16 x 3,5 ml Tot.: 57 ml
 Pcs/GiftBox: 6 | Pcs/SlimBox<: 12



RP05 MATTARELLO MINI

Item: 70.305.87.0069
 Size: Ø 25 x 228 mm
 Pcs/master: 24
 EAN: 8051085160983



RP06 MATTARELLO GRANDE

Item: 70.306.87.0069
 Size: Ø 40 x 400 mm
 Pcs/master: 6
 EAN: 8051085161003



LIS01 SMOOTHER

Item: 70.098.99.0069
 Pcs/Master: 4
 EAN: 8051085162987



WMAT02 - MATELASSÉ

Item: 23.062.19.0069
 Size: 600 x 400 h 3 mm
 Pcs/Master: 2
 EAN: 8051085158508



WMAT01 - POIS

Item: 23.063.19.0069
 Size: 600 x 400 h 3 mm
 Pcs/Master: 2
 EAN: 8051085158515



ROLL TOOL

Item: 72.341.19.0096
 Pcs/master: 6
 EAN: 8051085204250

**MODELLING TOLLS**

Set 8 pz/Pcs
 Item: 72.338.19.0096
 Pcs/master: 6
 EAN: 8051085183463

**PRECISION MAT**

Item: 23.014.19.0069
 Size: 400 x 300 mm
 Pcs/Master: 6
 EAN: 8051085217311

Item: 23.013.19.0069
 Size: 600 x 400 mm
 Pcs/Master: 6
 EAN: 8051085217281

**RP00 MATTARELLO REGOLABILE**

Item: 70.300.19.0069
 Size: Ø 40 x 400 mm
 Pcs/Master: 6
 EAN: 8051085175079

MATTARELLO REGOLABILE CON 3 ANELLI

Ai lati del mattarello possono essere inseriti 3 anelli di diverse dimensioni (1-2-3mm) per regolare l'altezza del mattarello e di conseguenza lo spessore della pasta.

ADJUSTABLE ROLLING PIN WITH 3 SILICONE RINGS

On the sides of the rolling pin you can insert 3 silicone rings of different sizes (0.03-0.07-0.11 inches) to regulate the height of the rolling pin and also the thickness of the paste

ROULEAU À PÂTISSERIE RÉGLABLE AVEC 3 ANNEAUX EN SILICONE
 Sur les côtés du rouleau à pâtisserie on peut insérer 3 anneaux en silicone de tailles différentes (1-2-3 mm) pour ajuster la hauteur du rouleau à pâtisserie et par conséquent l'épaisseur de la pâte.



SOTTOTORTA QUADRATO

☐ Item: 73.461.99.0001 Silver - EAN: 8051085223145

■ Item: 73.461.97.0001 Black - EAN: 8051085322077

Size: 200 x 200 mm | Pcs/Master: 24

☐ Item: 73.462.99.0001 Silver - EAN: 8051085223152

■ Item: 73.462.98.0001 Gold - EAN: 8051085292493

■ Item: 73.462.97.0001 Black - EAN: 8051085321964

Size: 250 x 250 mm | Pcs/Master: 24

☐ Item: 73.463.99.0001 Silver - EAN: 8051085223169

■ Item: 73.463.98.0001 Gold - EAN: 8051085292516

■ Item: 73.463.97.0001 Black - EAN: 8051085321988

Size: 300 x 300 mm | Pcs/Master: 24

☐ Item: 73.464.99.0001 Silver - EAN: 8051085223176

■ Item: 73.464.98.0001 Gold - EAN: 8051085292530

■ Item: 73.464.97.0001 Black - EAN: 8051085322008

Size: 350 x 350 mm | Pcs/Master: 24

☐ Item: 73.465.99.0001 Silver - EAN: 8051085226009

■ Item: 73.465.98.0001 Gold - EAN: 8051085292554

■ Item: 73.465.97.0001 Black - EAN: 8051085322022

Size: 400 x 400 mm | Pcs/Master: 24

☐ Item: 73.466.99.0001 Silver - EAN: 8051085223183

■ Item: 73.466.98.0001 Gold - EAN: 8051085292578

■ Item: 73.466.97.0001 Black - EAN: 8051085322046

Size: 450 x 450 mm | Pcs/Master: 24

SOTTOTORTA ROTONDO

☐ Item: 73.451.99.0001 Silver - EAN: 8051085223084

■ Item: 73.451.98.0001 Gold - EAN: 8051085292356

■ Item: 73.451.97.0001 Black - EAN: 8051085321827

Size: Ø 200 mm | Pcs/Master: 24

☐ Item: 73.452.99.0001 Silver - EAN: 8051085223091

■ Item: 73.452.98.0001 Gold - EAN: 8051085292370

■ Item: 73.452.97.0001 Black - EAN: 8051085321841

Size: Ø 250 mm | Pcs/Master: 24

☐ Item: 73.453.99.0001 Silver - EAN: 8051085223107

■ Item: 73.453.98.0001 Gold - EAN: 8051085292394

■ Item: 73.453.97.0001 Black - EAN: 8051085321865

Size: Ø 300 mm | Pcs/Master: 24

☐ Item: 73.454.99.0001 Silver - EAN: 8051085223114

■ Item: 73.454.98.0001 Gold - EAN: 8051085292417

■ Item: 73.454.97.0001 Black - EAN: 8051085321889

Size: Ø 350 mm | Pcs/Master: 24

☐ Item: 73.455.99.0001 Silver - EAN: 8051085223121

■ Item: 73.455.98.0001 Gold - EAN: 8051085292431

■ Item: 73.455.97.0001 Black - EAN: 8051085321902

Size: Ø 400 mm | Pcs/Master: 24

☐ Item: 73.456.99.0001 Silver - EAN: 8051085223138

■ Item: 73.456.98.0001 Gold - EAN: 8051085292455

■ Item: 73.456.97.0001 Black - EAN: 8051085321926

Size: Ø 450 mm | Pcs/Master: 24





SLK 801 - FIORE/BLOSSOM

Item: 71.801.39.0096
Size: Ø 37 mm
Pcs/master: 6
EAN: 8051085176809



SLK 804 - ORTENSIA/HYDRANGEA

Item: 71.804.39.0096
Size: 27 x 27 mm
Pcs/master: 6
EAN: 8051085176823



SLK 803 - MARGHERITA/DAISY

Item: 71.803.39.0096
Size: Ø 32 mm
Pcs/master: 6
EAN: 8051085176816



SLK 805 - PETUNIA

Item: 71.805.39.0096
Size: Ø 40 mm
Pcs/master: 6
EAN: 8051085176786



SLK 802 - FIORE DI CILIEGIO/CHERRY BLOSSOM

Item: 71.802.39.0096
Size: Ø 30 mm
Pcs/master: 6
EAN: 8051085176779



SLK 806 - FARFALLA/BUTTERFLY

Item: 71.806.39.0096
Size: 37 x 30 mm
Pcs/master: 6
EAN: 8051085176793



SLK 817 - MINI IVY

Item: 71.817.39.0096
Size: 35 x 30 x 30 mm
Pcs/master: 6 | EAN: 8051085284245



SLK 818 - IVY

Item: 71.818.39.0096
Size: 45 x 42 x 28 mm
Pcs/master: 6 | EAN: 8051085284269





SLK 807 - MINI FRANGIPANI

Item: 71.807.39.0096
 Size: Ø 30 mm
 Pcs/master: 6 | EAN: 8051085284283



SLK 808 - FRANGIPANI

Item: 71.808.39.0096
 Size: Ø 37 mm
 Pcs/master: 6 | EAN: 8051085284306



SLK 809 - MINI LILAC

Item: 71.809.39.0096
 Size: Ø 33 mm
 Pcs/master: 6 | EAN: 8051085284207



SLK 810 - LILAC

Item: 71.810.39.0096
 Size: Ø 40 mm
 Pcs/master: 6 | EAN: 8051085284221



SLK 811 - MINI STAR FLOWER

Item: 71.811.39.0096
 Size: Ø 31 mm
 Pcs/master: 6 | EAN: 8051085284368



SLK 812 - STAR FLOWER

Item: 71.812.39.0096
 Size: Ø 35 mm
 Pcs/master: 6 | EAN: 8051085284382



SLK 813 - MINI SPRING

Item: 71.813.39.0096
 Size: Ø 30 mm
 Pcs/master: 6 | EAN: 8051085284320



SLK 814 - SPRING

Item: 71.814.39.0096
 Size: Ø 35 mm
 Pcs/master: 6 | EAN: 8051085284344



SLK 815 - MINI LEAF

Item: 71.815.39.0096
 Size: Ø 31 mm
 Pcs/master: 6 | EAN: 8051085284405



SLK 816 - LEAF

Item: 71.816.39.0096
 Size: Ø 35 mm
 Pcs/master: 6 | EAN: 8051085288779





HEARTS

Set 50 Pcs
Item: 70.170.02.0063
EAN: 8051085258659



SNOWMAN

Set 24 Pcs
Item: 70.171.02.0063
EAN: 8051085258758



SKULL

Set 24 Pcs
Item: 70.171.01.0063
EAN: 8051085258734



TEATIME

Set 24 Pcs
Item: 70.171.04.0063
EAN: 8051085258796



CUPCAKES

Set 24 Pcs
Item: 70.171.03.0063
EAN: 8051085258772



BALLONS

Set 24 Pcs
Item: 70.171.05.0063
EAN: 8051085258819



HEARTS

Set 24 Pcs
Item: 70.172.03.0065
EAN: 8051085258857



WEDDING

Set 24 Pcs
Item: 70.172.01.0063
EAN: 8051085258833



WINTER

Set 24 Pcs
Item: 70.172.04.0065
EAN: 8051085258871



PARTY

Set 24 Pcs
Item: 70.172.05.0065
EAN: 8051085258895



FOOTBALL

Set 24 Pcs
Item: 70.172.02.0065
EAN: 8051085258918

DRESSES & TOOLS

SLK 198 - BOW

Item: 71.298.00.0096
Size: 44 x 45 mm
EAN: 8051085163861



SLK 281 - CROWNS

Item: 71.381.00.0096
size max: 58 x 24 mm
EAN: 8051085180127



SLK 340 - MEDIUM BOWS

Item: 71.440.00.0096
size max: 18 x 13 mm
EAN: 8032539932479



SLK 199 - BOWS

Item: 71.299.00.0096
size max: 35 x 25 mm
EAN: 8051085163878



SLK 339 - LOVE BOWS

Item: 71.439.00.0096
size max: 15 x 20 mm
EAN: 8032539932462



ANIMALS

SLK 021 - DINOSAURS

Item: 71.121.00.0096
size max: 15 x 20 mm
EAN: 8051085016112



SLK 073 - STARFISH

Item: 71.173.00.0096
Size: 50 x 50 mm
EAN: 8051085016631



SLK 077 - SHELL

Item: 71.177.00.0096
Size: 44 x 47 mm
EAN: 8051085016679



BABY**SLK 311 - BABY FOOTSTEPS**

Item: 71.411.00.0096
size max: 25 x 16 mm
EAN: 8032539931885

**SLK 312 - SLEEPING BABY**

Item: 71.412.00.0096
Size: 48 x 35 mm
EAN: 8032539931915

**SLK 403 - SLEEPING BABY**

Item: 71.503.00.0096
Size: 10 x 20 mm
EAN: 8051085224319

**SLK 326 - BIG NUMBERS**

Item: 71.426.00.0096
size max: 27 x 17 mm
EAN: 8032539932219

**SLK 328 - ALPHABET**

Item: 71.428.00.0096
size max: 18 x 15 mm
EAN: 8032539932257

**SLK 329 - ALPHABET CURSIVE**

Item: 71.429.00.0096
size max: 7 x 6 mm
EAN: 8032539932271

**DECORATIONS****SLK 144 - DECORO**

Item: 71.244.00.0096
Size: 53 x 25 mm
EAN: 8051085039708

**SLK 146 - DECORO**

Item: 71.246.00.0096
Size: 40 x 42 mm
EAN: 8051085039722

**SLK 142 - CROSS**

Item: 71.242.00.0096
size max: 36 x 48 mm
EAN: 8051085039685

**SLK 164 - TRAIN**

Item: 71.264.00.0096
Size: 50 x 25mm
EAN: 8051085039906

**FLOWERS****SLK 295 - ROSES**

Item: 71.395.00.0096
size max: 25 x 25 mm
EAN: 8051085180264

**SLK 351 - FLOWERS**

Item: 71.451.00.0096
size max: 22 x 23 mm
EAN: 8032539932738

**SLK 384 - ROSE**

Item: 71.484.00.0096
size max: 33 x 33 mm
EAN: 8051085100071

**SLK 908**

Item: 71.908.86.0096
Size: 100 x 60 mm
EAN: 8051085170043







ACC088 MINI COOKIE CUTTER NATURE

Item: 70.111.99.0069
49 x 50 h 18 mm
Pcs/master: 12
EAN: 8051085024322



ACC089 MINI COOKIE CUTTER LOVE

Item: 70.112.99.0069
50 x 43 h 18 mm
Pcs/master: 12
EAN: 8051085024339



ACC090 MINI COOKIE CUTTER EASTER

Item: 70.113.99.0069
50 x 36 h 18 mm
Pcs/master: 12
EAN: 8051085024346



ACC093 MINI COOKIE CUTTER ANIMALS

Item: 70.116.99.0069
47 x 45 h 18 mm
Pcs/master: 12
EAN: 8051085035779



ACC096 MINI COOKIE CUTTER SUMMER

Item: 70.119.99.0069
47 x 47 h 18 mm
Pcs/master: 12
EAN: 8051085035809



ACC101 MINI COOKIE CUTTER FUNNY ANIMAL

Item: 70.120.99.0069
47 x 45 h 18 mm
Pcs/master: 12
EAN: 8051085179183



ACC104 MINI COOKIE CUTTER JINGLE BELLS

Item: 70.123.99.0069
42 x 47 h 18 mm
Pcs/master: 12
EAN: 8051085179275



ACC 077 DOPPIO CUORE

Item: 70.100.03.0060
140 x 96 h 25 mm
Pcs/master: 12
EAN: 8051085011223



ACC 078 - ORSO

Item: 70.100.04.0060
87 x 106 h 25 mm
Pcs/master: 12
EAN: 8051085011230



ACCESSORIES

ACCESSORIES

In questa sezione troverai un'ampia gamma di kit e accessori ideali per arricchire e perfezionare le tue creazioni dolci e salate: fruste, spatole, taglia pasta, coperchi, sac à poche, tappetini, e tanti altri prodotti immancabili nella tua cucina.

Studiati e realizzati appositamente per soddisfare le esigenze di qualità e varietà di amatori e appassionati, la nostra linea di accessori comprende un ampio assortimento di prodotti versatili che ti permetteranno di risparmiare tempo e raggiungere risultati impeccabili in poche e semplici mosse.

In this section you will find a wide range of kits and accessories ideal for embellishing and improving your sweet and savory creations: whips, spatulas, pasta cutters, covers, piping bags, mats, and many other products which should not be missing in your kitchen. Specifically designed to meet the pastry enthusiasts' needs of quality and variety, our line of accessories includes a wide range of versatile products which allows you to save time and achieve impeccable results in just a few simple steps.

Dans cette section, vous trouverez une large gamme de kits et accessoires idéales pour enrichir vos créations sucrées ou salées: fouets, spatules, coupe-pâtes, couvercles, poches à douille et bien d'autres produits incontournables en cuisine. Conçue et fabriquée spécifiquement pour répondre aux besoins de qualité et variété des amateurs et des passionnés de pâtisserie, notre gamme comprend un large assortiment de produits polyvalents qui vous fera gagner du temps et obtenir des résultats impeccables.

Flower tube 01

Size: Ø 25 mm
43.421.99.0001
EAN: 8051085255559



Flower tube 02

Size: Ø 25 mm
43.422.99.0001
EAN: 8051085255573



Flower tube 03

Size: Ø 25 mm
43.423.99.0001
EAN: 8051085255894



Flower tube 04

Size: Ø 22 mm
43.424.99.0001
EAN: 8051085255917



Flower tube 05

Size: Ø 25 mm
43.425.99.0001
EAN: 8051085255931



Flower tube 06

Size: Ø 25 mm
43.426.99.0001
EAN: 8051085255955



Flower tube 07

Size: Ø 25 mm
43.427.99.0001
EAN: 8051085255979



Flower tube 08

Size: Ø 25 mm
43.428.99.0001
EAN: 8051085255993



Flower tube 09

Size: Ø 23 mm
43.429.99.0001
EAN: 8051085256013



Flower tube 10

Size: Ø 24 mm
43.430.99.0001
EAN: 8051085256037



Flower tube 11

Size: Ø 24 mm
43.431.99.0001
EAN: 8051085256129



Flower tube 12

Size: Ø 23 mm
43.432.99.0001
EAN: 8051085256051



Flower tube 13

Size: Ø 20 mm
43.433.99.0001
EAN: 8051085256075



Flower tube 14

Size: Ø 21 mm
43.434.99.0001
EAN: 8051085256099



Flower tube 17

Size: Ø 25 mm
43.437.99.0001
EAN: 8051085182015



Flower tube 18

Size: Ø 25 mm
43.438.99.0001
EAN: 8051085182022



Flower tube 19

Size: Ø 25 mm
43.439.99.0001
EAN: 8051085182039



Flower tube 20

Size: Ø 25 mm
43.470.99.0001
EAN: 8051085182084



Flower tube 21

Size: Ø 25 mm
43.471.99.0001
EAN: 8051085182091



Flower tube 22

Size: Ø 25 mm
43.472.99.0001
EAN: 8051085182107



Flower tube 23

Size: Ø 25 mm
43.473.99.0001
EAN: 8051085182114



Flower tube 24

Size: Ø 25 mm
43.474.99.0001
EAN: 8051085182121



Flower tube 25

Size: Ø 25 mm
43.475.99.0001
EAN: 8051085182138



Flower tube 26

Size: Ø 25 mm
43.476.99.0001
EAN: 8051085182145



Flower tube 27

Size: Ø 25 mm
43.477.99.0001
EAN: 8051085182152



Flower tube 28

Size: Ø 25 mm
43.478.99.0001
EAN: 8051085182169



Flower tube 29

Size: Ø 25 mm
43.479.99.0001
EAN: 8051085182176



Flower tube 30

Size: Ø 25 mm
43.480.99.0001
EAN: 8051085182183



Flower tube 31

Size: Ø 25 mm
43.481.99.0001
EAN: 8051085182190



Flower tube 32

Size: Ø 25 mm
43.482.99.0001
EAN: 8051085182725



Flower tube 33

Size: Ø 25 mm
43.483.99.0001
EAN: 8051085182732

**Flower tube 34**

Size: Ø 25 mm
43.484.99.0001
EAN: 8051085182749

**Flower tube 35**

Size: Ø 25 mm
43.485.99.0001
EAN: 8051085182916

**Flower tube 36**

Size: Ø 22 mm
43.486.99.0001
EAN: 8051085182923

**Flower tube 37**

Size: Ø 25 mm
43.487.99.0001
EAN: 8051085182978

**Flower tube 38**

Size: Ø 25 mm
43.488.99.0001
EAN: 8051085182985

**Flower tube 39**

Size: Ø 25 mm
43.489.99.0001
EAN: 8051085182992

**Flower tube 40**

Size: Ø 25 mm
43.490.99.0001
EAN: 8051085183029

**Snowflakes**

Size: Ø 23 mm
43.435.99.0001
EAN: 8051085181902

**Star tube**

Size: Ø 24 mm
43.436.99.0001
EAN: 8051085181971

**Flower tube 41**

Size: Ø 25 mm
43.491.99.0001
EAN: 8051085183036

**Flower tube 42**

Size: Ø 25 mm
43.492.99.0001
EAN: 8051085183043

**Flower tube 43**

Size: Ø 20 mm
43.493.99.0001
EAN: 8051085183050

**Flower tube 44**

Size: Ø 21 mm
43.494.99.0001
EAN: 8051085183067

**Flower tube 45**

Size: Ø 25 mm
43.495.99.0001
EAN: 8051085183074

**Flower tube 46**

Size: Ø 25 mm
43.496.99.0001
EAN: 8051085183081

**Flower tube 47**

Size: Ø 25 mm
43.497.99.0001
EAN: 8051085183098

**Flower tube 48**

Size: Ø 25 mm
43.498.99.0001
EAN: 8051085183104

**Flower tube 49**

Size: Ø 25 mm
43.499.99.0001
EAN: 8051085183135

**Flower tube 50**

Size: Ø 25 mm
43.650.99.0001
EAN: 8051085191239

**Flower tube 51**

Size: Ø 25 mm
43.651.99.0001
EAN: 8051085191604

**Flower tube 52**

Size: Ø 25 mm
43.652.99.0001
EAN: 8051085192021

**Flower tube 53**

Size: Ø 25 mm
43.653.99.0001
EAN: 8051085192472

**Flower tube 54**

Size: Ø 25 mm
43.654.99.0001
EAN: 8051085192809

**Mini Flower tube 01**

Size: Ø 18 mm
43.641.99.0001
EAN: 8051085190287

**Mini Flower tube 02**

Size: Ø 18 mm
43.642.99.0001
EAN: 8051085190492

**Mini Flower tube 03**

Size: Ø 18 mm
43.643.99.0001
EAN: 8051085190591

**Mini Flower tube 04**

Size: Ø 18 mm
43.644.99.0001
EAN: 8051085190645

**Mini Flower tube 05**

Size: Ø 18 mm
43.645.99.0001
EAN: 8051085190652

**Mini Flower tube 06**

Size: Ø 18 mm
43.646.99.0001
EAN: 8051085190720



Mini Flower tube 07
Size: Ø 18 mm
43.647.99.0001
EAN: 8051085191208



Mini Flower tube 08
Size: Ø 18 mm
43.648.99.0001
EAN: 8051085191215



Decor tube 10
Size: Ø 25 mm
43.610.99.0001
EAN: 8051085188635



Decor tube 11
Size: Ø 25 mm
43.611.99.0001
EAN: 8051085188659



Decor tube 06
Size: Ø 25 mm
43.606.99.0001
EAN: 8051085187683



Mini decor tube 04
Size: Ø 18 mm
43.624.99.0001
EAN: 8051085188710

Decor tube 01
Size: Ø 25 mm
43.601.99.0001
EAN: 8051085187416



Mini decor tube 02
Size: Ø 18 mm
43.622.99.0001
EAN: 8051085188697

Decor tube 05
Size: Ø 25 mm
43.605.99.0001
EAN: 8051085187560



Mini decor tube 03
Size: Ø 18 mm
43.623.99.0001
EAN: 8051085188703

Decor tube 09
Size: Ø 25 mm
43.609.99.0001
EAN: 8051085188611



Mini decor tube 05
Size: Ø 18 mm
43.625.99.0001
EAN: 8051085188727

Decor tube 04
Size: Ø 25 mm
43.604.99.0001
EAN: 8051085187553



Mini decor tube 06
Size: Ø 18 mm
43.626.99.0001
EAN: 8051085188734

Decor tube 07
Size: Ø 25 mm
43.620.99.0001
EAN: 8051085187744



Mini decor tube 01
Size: Ø 18 mm
43.621.99.0001
EAN: 8051085188680

Decor tube 02
Size: Ø 25 mm
43.602.99.0001
EAN: 8051085187423

Mini decor tube 07
Size: Ø 18 mm
43.627.99.0001
EAN: 8051085188741

Decor tube 03
Size: Ø 25 mm
43.603.99.0001
EAN: 8051085187546



Mini decor tube 08
Size: Ø 18 mm
43.628.99.0001
EAN: 8051085188758

Mini decor tube 10
Size: Ø 18 mm
43.630.99.0001
EAN: 8051085188772



Mini decor tube 11
Size: Ø 18 mm
43.631.99.0001
EAN: 8051085188970

Mini decor tube 12
Size: Ø 18 mm
43.632.99.0001
EAN: 8051085189106



Mini decor tube 13
Size: Ø 18 mm
43.633.99.0001
EAN: 8051085189618

Mini decor tube 14
Size: Ø 25 mm
43.634.99.0001
EAN: 8051085190058



Mini decor tube 15
Size: Ø 18 mm
43.635.99.0001
EAN: 8051085190256

Mini decor tube 09
Size: Ø 18 mm
43.629.99.0001
EAN: 8051085188765



Balls tubes regular
Size: Ø 25 mm
43.615.99.0001
EAN: 8051085188666



Balls tubes irregular
Size: Ø 25 mm
43.616.99.0001
EAN: 8051085188673



Ball tube swirl
Size: Ø 25 mm
43.617.99.0001
EAN: 8051085299270



Flower nails 01

Size: Ø 21 mm
Set 3 pz/Pcs
43.461.99.0096
EAN: 8051085274840



Flower nails 03

Size: Ø 35 mm
Set 3 pz/Pcs
43.463.99.0096
EAN: 8051085274888



Flower nails 04

Size: Ø 35 mm
Set 3 pz/Pcs
43.464.99.0096
EAN: 8051085274901



Flower nails 06

Size: Ø 35 mm
Set 3 pz/Pcs
43.466.99.0096
EAN: 8051085274949



Color twist big

Size: Ø 25 mm
70.179.01.0096
EAN: 8051085278558



Color twist small

Size: Ø 18 mm
70.178.01.0096
EAN: 8051085278572



Adattatore bocchette

Small Size: Ø 1.5 mm
70.180.01.0096
EAN: 8051085278497



Adattatore bocchette

Medium Size: Ø 2.5 mm
70.181.01.0096
EAN: 8051085278510



Adattatore bocchette

Large Size: Ø 3 mm
70.182.01.0096
EAN: 8051085278534



LISTA PUNTE PER UTILIZZO COLOR TWIST
LIST OF POINTS FOR COLOR TWIST USAGE

LISTE DES DOUILLES POUR L'UTILISATION DU COLOR TWIST

Big

- 43.421.99.0001
- 43.422.99.0001
- 43.423.99.0001
- 43.424.99.0001
- 43.425.99.0001
- 43.426.99.0001
- 43.427.99.0001
- 43.428.99.0001
- 43.429.99.0001
- 43.430.99.0001
- 43.431.99.0001
- 43.432.99.0001
- 43.433.99.0001
- 43.434.99.0001
- 43.435.99.0001
- 43.436.99.0001
- 43.437.99.0001
- 43.438.99.0001
- 43.439.99.0001
- 43.470.99.0001
- 43.471.99.0001
- 43.472.99.0001
- 43.473.99.0001
- 43.474.99.0001
- 43.475.99.0001
- 43.476.99.0001
- 43.477.99.0001
- 43.478.99.0001
- 43.479.99.0001
- 43.480.99.0001
- 43.481.99.0001
- 43.482.99.0001
- 43.483.99.0001
- 43.484.99.0001
- 43.485.99.0001
- 43.486.99.0001
- 43.487.99.0001
- 43.488.99.0001
- 43.489.99.0001
- 43.490.99.0001
- 43.491.99.0001
- 43.492.99.0001
- 43.493.99.0001
- 43.494.99.0001
- 43.495.99.0001
- 43.496.99.0001
- 43.497.99.0001
- 43.498.99.0001
- 43.499.99.0001
- 43.450.99.0001
- 43.451.99.0001
- 43.452.99.0001
- 43.453.99.0001
- 43.454.99.0001

Small

- 43.641.99.0001
- 43.642.99.0001
- 43.643.99.0001
- 43.644.99.0001
- 43.645.99.0001
- 43.646.99.0001
- 43.647.99.0001
- 43.648.99.0001
- 43.336.99.0000
- 43.337.99.0000
- 43.338.99.0000
- 43.339.99.0000
- 43.325.99.0000
- 43.326.99.0000
- 43.327.99.0000
- 43.387.99.0000
- 43.388.99.0000
- 43.389.99.0000
- 43.390.99.0000
- 43.310.99.0000
- 43.311.99.0000
- 43.312.99.0000
- 43.313.99.0000
- 43.314.99.0000
- 43.346.99.0000
- 43.347.99.0000
- 43.372.99.0000
- 43.375.99.0000
- 43.358.99.0000
- 43.360.99.0000
- 43.361.99.0000
- 43.350.99.0000
- 43.343.99.0000
- 43.344.99.0000
- 43.615.99.0001
- 43.616.99.0001

Small

- 43.332.99.0000
- 43.333.99.0000
- 43.334.99.0000
- 43.335.99.0000
- 43.320.99.0000
- 43.321.99.0000
- 43.322.99.0000
- 43.323.99.0000
- 43.324.99.0000
- 43.379.99.0000
- 43.380.99.0000
- 43.381.99.0000
- 43.382.99.0000
- 43.383.99.0000
- 43.384.99.0000
- 43.385.99.0000
- 43.386.99.0000
- 43.301.99.0000
- 43.302.99.0000
- 43.303.99.0000
- 43.304.99.0000
- 43.305.99.0000
- 43.306.99.0000
- 43.307.99.0000
- 43.308.99.0000
- 43.309.99.0000
- 43.363.99.0000
- 43.364.99.0000
- 43.352.99.0000
- 43.366.99.0000
- 43.367.99.0000
- 43.368.99.0000
- 43.371.99.0000
- 43.370.99.0000
- 43.374.99.0000
- 43.373.99.0000
- 43.353.99.0000
- 43.376.99.0000
- 43.377.99.0000
- 43.355.99.0000
- 43.349.99.0000
- Mini Flower
- Bim Media
- Bim Grande

Medium

- 43.336.99.0000
- 43.337.99.0000
- 43.338.99.0000
- 43.339.99.0000
- 43.325.99.0000
- 43.326.99.0000
- 43.327.99.0000
- 43.387.99.0000
- 43.388.99.0000
- 43.389.99.0000
- 43.390.99.0000
- 43.310.99.0000
- 43.311.99.0000
- 43.312.99.0000
- 43.313.99.0000
- 43.314.99.0000
- 43.346.99.0000
- 43.347.99.0000
- 43.372.99.0000
- 43.375.99.0000
- 43.378.99.0000
- 43.369.99.0000
- 43.356.99.0000
- 43.357.99.0000
- 43.358.99.0000
- 43.360.99.0000
- 43.361.99.0000
- 43.350.99.0000
- 43.343.99.0000
- 43.344.99.0000
- 43.615.99.0001
- 43.616.99.0001

Big

- 43.421.99.0001
- 43.422.99.0001
- 43.423.99.0001
- 43.424.99.0001
- 43.425.99.0001
- 43.426.99.0001
- 43.427.99.0001
- 43.428.99.0001
- 43.429.99.0001
- 43.430.99.0001
- 43.431.99.0001
- 43.432.99.0001
- 43.433.99.0001
- 43.434.99.0001
- 43.435.99.0001
- 43.436.99.0001
- 43.437.99.0001
- 43.438.99.0001
- 43.439.99.0001
- 43.470.99.0001
- 43.471.99.0001
- 43.472.99.0001
- 43.473.99.0001
- 43.474.99.0001
- 43.475.99.0001
- 43.476.99.0001
- 43.477.99.0001
- 43.478.99.0001
- 43.479.99.0001
- 43.480.99.0001
- 43.481.99.0001
- 43.482.99.0001
- 43.483.99.0001
- 43.484.99.0001
- 43.485.99.0001
- 43.486.99.0001
- 43.487.99.0001
- 43.488.99.0001
- 43.489.99.0001
- 43.490.99.0001
- 43.491.99.0001
- 43.492.99.0001
- 43.493.99.0001
- 43.494.99.0001
- 43.495.99.0001
- 43.496.99.0001
- 43.497.99.0001
- 43.498.99.0001
- 43.499.99.0001
- 43.450.99.0001
- 43.451.99.0001
- 43.452.99.0001
- 43.453.99.0001
- 43.454.99.0001

STAR FRENCH TUBES



Name	Item	Size	Ean code
BF 310	43.332.99.0000	Ø4mm	8051085118953
BF 311	43.333.99.0000	Ø6mm	8051085118960
BF 312	43.334.99.0000	Ø7mm	8051085118977
BF 313	43.335.99.0000	Ø9mm	8051085118984
BF 314	43.336.99.0000	Ø10mm	8051085118991
BF314/11	43.337.99.0000	Ø11mm	8051085119004
BF 315	43.338.99.0000	Ø12mm	8051085119011
BF 316	43.339.99.0000	Ø13mm	8051085119028
BF 317	43.340.99.0000	Ø15mm	8051085119035
BF 318	43.341.99.0000	Ø16mm	8051085119042
BF 319	43.342.99.0000	Ø18mm	8051085119059

CLOSE STAR TUBES



Name	Item	Size	Ean code
BC 320	43.321.99.0000	Ø2mm	8051085118847
BC 321	43.322.99.0000	Ø3mm	8051085118854
BC 322	43.323.99.0000	Ø4mm	8051085118861
BC 323	43.324.99.0000	Ø5mm	8051085118878
BC 324	43.325.99.0000	Ø6mm	8051085118885
BC 325	43.326.99.0000	Ø7mm	8051085118892
BC 326	43.327.99.0000	Ø8mm	8051085118908
BC 327	43.328.99.0000	Ø9mm	8051085118915
BC 328	43.329.99.0000	Ø10mm	8051085118922
BC 329	43.330.99.0000	Ø11mm	8051085118939
BC 330	43.331.99.0000	Ø12mm	8051085118946

STAR TUBES



Name	Item	Size	Ean code
BS 102	43.379.99.0000	Ø2mm	8051085119424
BS 103	43.380.99.0000	Ø3mm	8051085119431
BS 104	43.381.99.0000	Ø4mm	8051085119448
BS 105	43.382.99.0000	Ø5mm	8051085119455
BS 106	43.383.99.0000	Ø6mm	8051085119462
BS 107	43.384.99.0000	Ø7mm	8051085119479
BS 108	43.385.99.0000	Ø8mm	8051085119486
BS 109	43.386.99.0000	Ø9mm	8051085119493
BS 110	43.387.99.0000	Ø10mm	8051085119509
BS 111	43.388.99.0000	Ø11mm	8051085119516
BS 112	43.389.99.0000	Ø12mm	8051085119523
BS 113	43.390.99.0000	Ø13mm	8051085119530
BS 114	43.391.99.0000	Ø14mm	8051085119547
BS 115	43.392.99.0000	Ø15mm	8051085119554
BS 116	43.393.99.0000	Ø16mm	8051085119561
BS 117	43.394.99.0000	Ø17mm	8051085119578
BS 118	43.395.99.0000	Ø18mm	8051085119585

ROUND TUBES



Name	Item	Size	Ean code
BT 202	43.301.99.0000	Ø2mm	8051085118649
BT 203	43.302.99.0000	Ø3mm	8051085118656
BT 204	43.303.99.0000	Ø4mm	8051085118663
BT 205	43.304.99.0000	Ø5mm	8051085118670
BT 206	43.305.99.0000	Ø6mm	8051085118687
BT 207	43.306.99.0000	Ø7mm	8051085118694
BT 208	43.307.99.0000	Ø8mm	8051085118700
BT 209	43.308.99.0000	Ø9mm	8051085118717
BT 210	43.309.99.0000	Ø10mm	8051085118724
BT 211	43.310.99.0000	Ø11mm	8051085118731
BT 212	43.311.99.0000	Ø12mm	8051085118748
BT 213	43.312.99.0000	Ø13mm	8051085118755
BT 214	43.313.99.0000	Ø14mm	8051085118762
BT 215	43.314.99.0000	Ø15mm	8051085118779
BT 216	43.315.99.0000	Ø16mm	8051085118786
BT 217	43.316.99.0000	Ø17mm	8051085118793
BT 218	43.317.99.0000	Ø18mm	8051085118809
BT 220	43.318.99.0000	Ø20mm	8051085118816
BT 222	43.319.99.0000	Ø22mm	8051085118823
BT 224	43.320.99.0000	Ø24mm	8051085118830

OPEN FLOWER TUBES



Name	Item	Size	Ean code
BA 411	43.346.99.0000	small	8051085119097
BA 413	43.347.99.0000	medium	8051085119103
BA 415	43.348.99.0000	large	8051085119110

OPEN FLOWER LEAVES



Name	Item	Size	Ean code
BX1105	43.362.99.0000	Ø5h 42mm	8051085119257
BX1115	43.363.99.0000	Ø4h 42mm	8051085119264
BX1123	43.364.99.0000	Ø3h 42mm	8051085119271
BX1132	43.365.99.0000	Ø2h 42mm	8051085119288

STAR RIBBON TUBES



Name	Item	Size	Ean
BR 330	43.343.99.0000	small	8051085119066
BR 331	43.344.99.0000	medium	8051085119073
BR 332	43.345.99.0000	large	8051085119080

FLOWER TUBES



Name	Item	Size	Ean
BD 300	43.349.99.0000	small	8051085119127
BD 301	43.350.99.0000	medium	8051085119134
BD 302	43.351.99.0000	large	8051085119141

BX 1013



Name	Item	Size	Ean
BX1013	43.352.99.0000	Ø 13 h 43 mm	8051085119158

BX 1303



Name	Item	Size	Ean
BX1303	43.367.99.0000	3 x 17 h 40 mm	8051085119301

BX 1217



Name	Item	Size	Ean
BX1217	43.366.99.0000	3 x 17 h 40 mm	8051085119295

BX 1405



Name	Item	Size	Ean
BX1405	43.368.99.0000	5 x 20 h 43 mm	8051085119318

BX 1510



Name	Item	Size	Ean
BX1510	43.369.99.0000	10 x 22 h 52 mm	8051085119325

BX 1713



Name	Item	Size	Ean
BX1713	43.371.99.0000	Ø 13 h 40 mm	8051085119349

BX 1605



Name	Item	Size	Ean
BX1605	43.370.99.0000	8 x 5 h 52 mm	8051085119332

BX 1820



Name	Item	Size	Ean
BX1820	43.372.99.0000	Ø 20 h 42 mm	8051085119356

BX 2117



Name	Item	Size	Ean
BX2117	43.374.99.0000	Ø 17 h 45 mm	8051085119370

BX 1906



Name	Item	Size	Ean
BX1906	43.373.99.0000	Ø17 x 6 h47mm	8051085119363

BX 2013



Name	Item	Size	Ean
BX2013	43.353.99.0000	Ø 13 h 42 mm	8051085119165

BX 2119



Name	Item	Size	Ean
BX2119	43.375.99.0000	Ø 19 h 52 mm	8051085119387

BX 2312



Name	Item	Size	Ean
BX2312	43.376.99.0000	Ø12 h41mm	8051085119394
BX2314	43.377.99.0000	Ø14 h39mm	8051085119400
BX2315	43.378.99.0000	Ø15 h46mm	8051085119417

BX 3005



Name	Item	Size	Ean
BX3005	43.354.99.0000	Ø5 h50mm	8051085119172

BX 5017



Name	Item	Size	Ean
BX5017	43.356.99.0000	Ø17 h47mm	8051085119196

BX 6018



Name	Item	Size	Ean
BX6018	43.357.99.0000	Ø18 h48mm	8051085119202

BX 4014



Name	Item	Size	Ean
BX4014	43.355.99.0000	Ø14 h50mm	8051085119189

BX 7020



Name	Item	Size	Ean
BX7020	43.358.99.0000	Ø20 h52mm	8051085119219

BX 8019



Name	Item	size	Ean
BX8019	43.359.99.0000	Ø19h 52mm	8051085119226

BX 9017



Name	Item	size	Ean
BX9017	43.360.99.0000	3x17 h52mm	8051085119233
BX9022	43.361.99.0000	3x22 h53mm	8051085119240

BIM 340

Name	Item	Ean
BIM340	70.529.99.0066	8051085220304
Ø6x63mm	43.457.99.0001	8051085182046
Ø6x75mm	43.458.99.0001	8051085182053
Ø8x92mm	43.459.99.0001	8051085182077



Ideale per riempire cannoli, krafen e bigné
 Perfect for stuff cream horns, krafens, cream puffs
 Idéal pour farcir cannoli, krafpens et choux

BRUSCHINO

Name	Item	Ean
BRU	41.090.99.0000	4028574005081



BS 10 T

Size: From Ø 4 to Ø 15mm
Set 10 pz/Pcs
43.096.99.0000
EAN: 8051085118137



BX 10 S

Size: From Ø 4 to Ø 15mm
Set 10 pz/Pcs
43.097.99.0000
EAN: 8051085118144



BOS 26

Set 26 pz/Pcs
40.805.99.0000
EAN: 4028574005104



BOS 36 BIG

Set 39 pz/Pcs
40.454.99.0000
EAN: 4028574005128



BOS 52

Set 55 pz/Pcs
40.716.00.0000
EAN: 4028574005111



BPC 6C

Punte pasticceria
Set 6 pz/Pcs
73.103.99.0096
EAN: 8051085052233



polycarbonate

BPC 6A

Punte stella
Set 6 pz/Pcs
73.101.99.0096
EAN: 8051085052219



polycarbonate

BPC 12A

Punte stella + tonde
Set 12 pz/Pcs
73.104.99.0096
EAN: 8051085052240



polycarbonate

BPC 12B

Mixed pasticceria
Set 12 pz/Pcs
73.105.99.0096
EAN: 8051085052257



polycarbonate

RELIGIEUSE TUBE 01

Close
Size: Ø 30 mm
43.443.99.0001
EAN: 8051085263547



MINI RELIGIEUSE TUBE 01

Close
Size: Ø 18 mm
43.455.99.0001
EAN: 8051085302253



RELIGIEUSE TUBE 02

Open
Size: Ø 30 mm
43.444.99.0001
EAN: 8051085263561



MINI RELIGIEUSE TUBE 02

Open
Size: Ø 18 mm
43.456.99.0001
EAN: 8051085302277



PIPING BAGS

70.143.99.0066 | 20 mm
EAN: 8051085215355

70.144.99.0066 | 25 mm
EAN: 8051085215379

70.145.99.0066 | 30 mm
EAN: 8051085215386

70.146.99.0066 | 35 mm
EAN: 8051085215423

70.147.99.0066 | 40 mm
EAN: 8051085215409

SAC À POCHE

Size: 34 mm
Set 3 punte tonde
+3 punte stella
70.033.99.0060
EAN: 8051085010080



DISPOSABLE PIPING BAGS

Size: 36 mm
Set 24 pz/Pcs
70.097.99.0065
EAN: 8051085233588



DISPOSABLE PIPING BAGS

Size: 56 mm
Set 24 pz/Pcs
70.149.99.0065
EAN: 8051085286751



SILICONE PIPING BAGS

Size: Ø 185 h 450 mm
70.300.86.0160
EAN: 8051085019717



VASO SAC À POCHE

72.336.99.0098
EAN: 8051085046263



ACC042 CASTELLO

Size: Ø240mm
70.020.99.0060
EAN: 8032539938075



ACC055 - TORTA YOGURT

Size: Ø240mm
70.015.99.0060
EAN: 8032539938204



ACC050 FANTASIA

Size: Ø240mm
70.005.99.0060
EAN: 8032539938150



COTTON PIPING BAGS

41.943.99.0000
41.944.99.0000
40.871.00.0000
40.856.00.0000
40.891.00.0000
41.598.99.0000
41.945.99.0000
41.599.99.0000
41.946.99.0000
41.947.99.0000
41.948.99.0000



MADE IN GERMANY

8051085051236
8051085051243
8051085051250
8051085051267
8051085051274
8051085051281
8051085051298
8051085051304
8051085051311
8051085051328
8051085051335

STD	025	25 cm
STD	028	28 cm
STD	034	34 cm
STD	040	40 cm
STD	046	46 cm
STD	050	50 cm
STD	055	55 cm
STD	060	60 cm
STD	065	65 cm
STD	070	70 cm
STD	075	75 cm

STRAIGHT SPATULAS

Spatola Inox con manico in plastica.
 Inox vake slice with plastic hand
 Spatule en acier inoxydable avec manche en plastique
 Pcs/master: 12

SP 20

Size: 20 cm
 Item: 73.431.99.0001
 EAN: 8051085195039

SP 28

Size: 28 cm
 Item: 73.432.99.0001
 EAN: 8051085195046

SP 33

Size: 33 cm
 Item: 73.433.99.0001
 EAN: 8051085215829

SP 38

Size: 38 cm
 Item: 73.434.99.0001
 EAN: 8051085215836

SP 43

Size: 43 cm
 Item: 73.437.99.0001
 EAN: 8051085215843

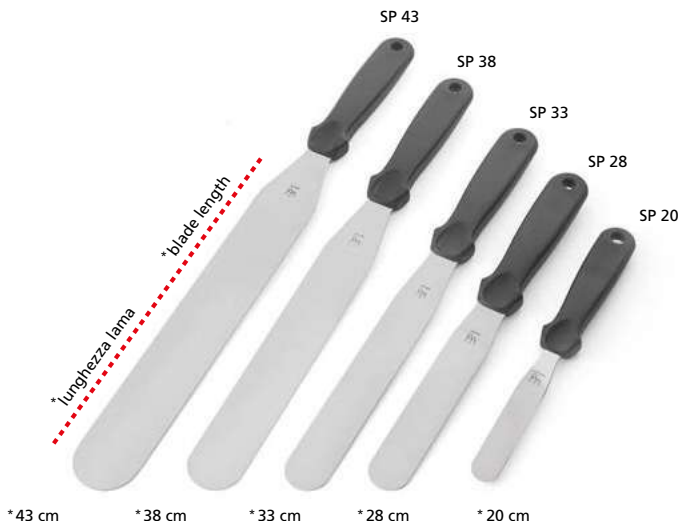

EDGED SPATULAS

Spatola angolare con manico in plastica, lama in acciaio inox flessibile.
 Edged spatula with plastic handle, flexible stainless steel blade.
 Spatule coudée avec manche en plastique, lame flexible en acier inoxydable.
 Pcs/master: 12

SP-ANG 20

Size: 20 cm
 Item: 73.435.99.0001
 EAN: 8051085195053

SP-ANG 33

Size: 33 cm
 Item: 73.436.99.0001
 EAN: 8051085195060

SP-ANG 38

Size: 38 cm
 Item: 73.438.99.0001
 EAN: 8051085215850



SP SPECIAL 20

Spatola appuntita con manico in plastica, lama in acciaio inox.
 Pointed spatula with plastic handle, stainless steel blade.
 Spatule pointue avec manche en plastique, lame en acier inoxydable.
 Pcs/master: 12

Size: 20 cm
 Item: 73.439.99.0001
 EAN: 8051085215904

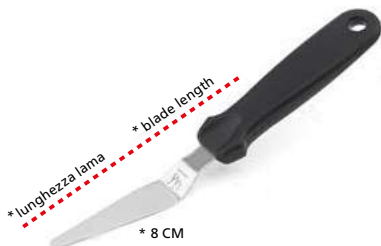

SCRAPER

SPATULA

Size: 120 x 120 mm
 70.141.00.0001
 EAN: 8051085201396

SCRAPER 01

Size: 130 mm
 70.157.99.0001
 EAN: 8051085286782

SCRAPER 02

Size: 175 mm
 70.158.99.0001
 EAN: 8051085286799



WHISK

Item: 73.446.99.0001
 Mini Size: 210 - Ø 50 mm
 EAN: 8051085323623

Item: 73.447.99.0001
 Medium Size: 245 - Ø 60 mm
 EAN: 8051085323630

Item: 73.448.99.0001
 Maxi Size: 300 - Ø 70 mm
 EAN: 8051085323647

**COOLING GRID**

Item: 73.442.99.0001
 Round Size: 300 mm
 EAN: 8051085195084
 Pcs/master: 10

**SILICONE SPATULA**

Item: 70.101.87.0002
 Size: 25 cm
 EAN: 8051085048588

Item: 70.102.87.0002
 Size: 36 cm
 EAN: 8051085048618

Item: 70.103.87.0002
 Size: 41 cm
 EAN: 8051085048625

**SILICONE SPOON**

Item: 70.104.87.0002
 Size: 25 cm
 EAN: 8051085048694

Item: 70.105.87.0002
 Size: 36 cm
 EAN: 8051085048700

Item: 70.106.87.0002
 Size: 41 cm
 EAN: 8051085048717

**GRADUAL BOTTLES**

Volume: 100 ml
 Item: 70.136.99.0061
 EAN: 8051085244997

Volume: 250 ml
 Item: 70.137.99.0061
 EAN: 8051085245000

Volume: 500 ml
 Item: 70.138.99.0061
 EAN: 8051085245017

**PENNA DECORATIVA 5 PUNTE**

Vol: 60 ml
 Item: 72.342.86.0065
 EAN: 8051085233717
 Pcs/master: 6

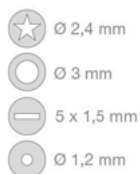
**STAINLESS CAKE TRAY**

Item: 70.132.99.0001
 Size: 280 x 330 mm
 EAN: 8051085178193
 Pcs/master: 6

**PVC ROLL**

Item: 73.494.86.0001
 Size: h 40 mm x 10 m
 EAN: 8051085279449

Item: 73.498.86.0001
 Size: h 60 mm x 10 m
 EAN: 8051085279487

Item: 73.491.86.0001
 Size: h 25 mm x 10 m
 EAN: 8051085279425

Item: 73.492.86.0001
 Size: h 30 mm x 10 m
 EAN: 8051085279418

Item: 73.493.86.0001
 Size: h 35 mm x 10 m
 EAN: 8051085279432

Item: 73.495.86.0001
 Size: h 45 mm x 10 m
 EAN: 8051085279456

**CARAMELLATORE**

Volume: 20 ml
 Item: 70.056.99.0001
 EAN: 8032539934138
 Pcs/master: 10

Volume: 60 ml
 Item: 70.058.99.0001
 EAN: 8032539934145
 Pcs/master: 10

**EASY THERMO**

Item: 70.125.99.0096
 EAN: 8051085193158
 Pcs/master: 10



CAKES CUTTER

Cookie cutters sets to make cookies and sugar paste or chocolate paste decorations; each set allows you to create nice shapes for decorating cup cakes, cookies and cupcakes.

IRREGULAR



REGULAR

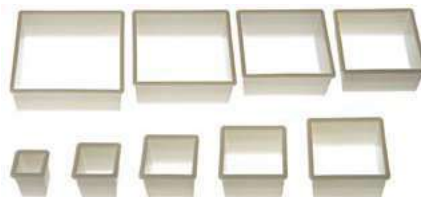

CUTTER 03 IRREGULAR SQUARE

Item: 72.303.87.0069
 Size: 3x3 - 4x4 - 5x5 - 6x6 - 7x7 - 8x8 - 9x9 - 10x10 - 11x11 cm
 EAN: 8051085151677



CUTTER 06 REGULAR HEXAGON

Item: 72.306.87.0069
 Size: 3x2.5 - 4x3.5 - 5x4.5 - 6x5.5 - 7.5x6.5 - 8.5x7.5 - 9.5x8.5 - 10.5x9 - 12x10 cm -
 EAN: 8051085151707



CUTTER 08 REGULAR OVAL

Item: 72.308.87.0069
 Size: 3x4.3 - 3.9x5.7 - 5x7 - 5.9x8.3 - 6.9x9.6 - 7.8x11 - 8.8x12.3 cm -
 EAN: 8051085151721

CUTTER 05 IRREGULAR HEXAGON

Item: 72.305.87.0069
 Size: 3x2.5 - 4x3.5 - 5x4.5 - 6x5.5 - 7.5x6.5 - 8.5x7.5 - 9.5x8.5 - 10.5x9 - 12x10 cm -
 EAN: 8051085151691

CUTTER 07 IRREGULAR OVAL

Item: 72.307.87.0069
 Size: 3x4.3 - 3.9x5.7 - 5x7 - 5.9x8.3 - 6.9x9.6 - 7.8x11 - 8.8x12.3 cm -
 EAN: 8051085151714



CUTTER 10 REGULAR CLOVER

Item: 72.310.87.0069
 Size: Ø2.9 - 4.1 - 5.4 - 6.8 - 8.3 - 9.3 - 10.8 - 12.4 cm
 EAN: 8051085151745



CUTTER 12 REGULAR STAR OF DAVID

Item: 72.312.87.0069
 Size: Ø4 - 5.5 - 7 - 8.5 - 10 - 11.5 - 13 cm
 EAN: 8051085151769

CUTTER 09 IRREGULAR CLOVER

Item: 72.309.87.0069
 Size: Ø2.9 - 4.1 - 5.4 - 6.8 - 8.3 - 9.3 - 10.8 - 12.4 cm
 EAN: 8051085151738

CUTTER 11 IRREGULAR STAR OF DAVID

Item: 72.311.87.0069
 Size: Ø2.9 - 5.4 - 7.5 - 10.1 - 12.7 cm
 EAN: 8051085151752



CUTTER 16 REGULAR MOON

Item: 72.316.87.0069
 Size: 8x3.5 - 9x4.5 - 9.5x6 - 10x7 - 11.5x8 - 12x9.5 - 13x10.5 cm
 EAN: 8051085151806

CUTTER 15 IRREGULAR MOON

Item: 72.315.87.0069
 Size: 8x3.5 - 9x4.5 - 9.5x6 - 10x7 - 11.5x8 - 12x9.5 - 13x10.5 cm
 EAN: 8051085151790



CUTTER 18 REGULAR FLOWER

Item: 72.318.87.0069
 Size: Ø3.5 - 4.5 - 6 - 7 - 8 - 9.5 - 10.5 - 12 cm
 EAN: 8051085151820

CUTTER 17 IRREGULAR FLOWER

Item: 72.317.87.0069
 Size: Ø3.5 - 4.5 - 6 - 7 - 8 - 9.5 - 10.5 - 12 cm
 EAN: 8051085151813



CUTTER 20 REGULAR BOAT

Item: 72.320.87.0069
 Size: 3x2 - 4.5x3 - 6x3.5 - 7.5x4.5 - 9x5.5 - 10.5x6.5 - 12x7.5 cm
 EAN: 8051085151844

CUTTER 19 IRREGULAR BOAT

Item: 72.319.87.0069
 Size: 3x2 - 4.5x3 - 6x3.5 - 7.5x4.5 - 9x5.5 - 10.5x6.5 - 12x7.5 cm
 EAN: 8051085151837

STRUDEL CUTTING

Size: 60 mm
 Item: 70.038.01.0001
 EAN: 8032539933933



ROLLER DOCKERS

Size: 120 mm
 Item: 70.037.01.0001
 EAN: 8032539933926



CUTTING ROLLERS

Size: 120 mm
 Item: 70.036.01.0001
 EAN: 8032539933919



ACC04 MATTARELLO

Size: Ø50mm h 220mm
 Item: 70.028.99.0001
 EAN: 8032539933810
 Pcs/master: 3



ACC05 MATTARELLO

Size: Ø85mm h 300mm
 Item: 70.029.99.0001
 EAN: 8032539933827



SMART IN THE KITCHEN





SILIKOMART®
MADE IN ITALY TWISTO

GRIPPY®

GRIPPY

Item: 70.202.55.0001

Size: 128 x 120 h 66 mm



Pcs/Display: 40

EAN: 8051085361366







ACC 022 PENNELLO PICCOLO

-  Item: 70.048.10.0001
EAN: 8051085010134
-  Item: 70.048.60.0001
EAN: 8051085010141
-  Item: 70.048.72.0001
EAN: 8051085010158

180mm





ACC 023 PENNELLO MEDIO

-  Item: 70.049.10.0001
EAN: 8051085010165
-  Item: 70.049.60.0001
EAN: 8051085010172
-  Item: 70.049.72.0001
EAN: 8051085010189

210mm







ACC 024 PENNELLO BARBEQUE

-  Item: 70.050.10.0001
EAN: 8051085010196
-  Item: 70.050.60.0001
EAN: 8051085010202
-  Item: 70.050.72.0001
EAN: 8051085010219

370mm





**ACC 026
SPATOLA PICCOLA**

-  Item: 70.052.10.0001
EAN: 8051085010257
-  Item: 70.052.17.0001
EAN: 8051085010264
-  Item: 70.052.48.0001
EAN: 8051085010271
-  Item: 70.052.60.0001
EAN: 8051085010288
-  Item: 70.052.87.0001
EAN: 8051085010295

245mm







**ACC 027
SPATOLA GRANDE**

-  Item: 70.053.10.0001
EAN: 8051085010301
-  Item: 70.053.17.0001
EAN: 8051085010318
-  Item: 70.053.48.0001
EAN: 8051085010325
-  Item: 70.053.60.0001
EAN: 8051085010332
-  Item: 70.053.87.0001
EAN: 8051085010349

260mm







**ACC 028
CUCCHIAIO SPATOLA**

-  Item: 70.054.10.0001
EAN: 8051085010356
-  Item: 70.054.17.0001
EAN: 8051085010363
-  Item: 70.054.48.0001
EAN: 8051085010370
-  Item: 70.054.60.0001
EAN: 8051085010387
-  Item: 70.054.87.0001
EAN: 8051085010394

255mm



**ACC 029 SPATOLE
SET 3 PCS**

-  Item: 70.055.10.0001
EAN: 8051085010400
-  Item: 70.055.17.0001
EAN: 8051085010417
-  Item: 70.055.48.0001
EAN: 8051085010424
-  Item: 70.055.60.0001
EAN: 8051085010431
-  Item: 70.055.87.0001
EAN: 8051085010448

245 - 260 - 255 mm



ACC 071 MISS HOT

 Item: 70.199.05.0001
EAN: 8032539934251

 Item: 70.199.12.0001
EAN: 8051085010592

 Item: 70.199.20.0001
EAN: 8051085010608

 Item: 70.199.55.0001
EAN: 8051085010622

Size: 175 x 175 mm

Pcs/Master: 6

 Item: 70.199.72.0001
EAN: 8051085010639

 Item: 70.199.62.0001
EAN: 8051085048151



ACC 074 PRESI

 Item: 70.198.05.0001
EAN: 8032539934374

 Item: 70.198.12.0001
EAN: 8051085010899

 Item: 70.198.20.0001
EAN: 8051085010905

Size: 175 x 175 mm

Pcs/Master: 6

 Item: 70.198.55.0001
EAN: 8051085010912

 Item: 70.198.72.0001
EAN: 8051085010929



ACC 072 ZEUS

 Item: 70.200.05.0001
EAN: 8032539934398

 Item: 70.200.12.0001
EAN: 8051085010974

 Item: 70.200.20.0001
EAN: 8051085010981

Size: 285 x 168 mm

Pcs/Master: 6

 Item: 70.200.55.0001
EAN: 8051085010998

**ACC 073 MISTER HOT**

 Item: 70.400.05.0001
EAN: 8032539934381

 Item: 70.400.12.0001
EAN: 8051085010936

 Item: 70.400.20.0001
EAN: 8051085010943

Size: 274 x 167 mm

Pcs/Master: 6

 Item: 70.400.62.0001
EAN: 8051085140084

 Item: 70.400.55.0001
EAN: 8051085010950

**ACC 082 PROFI ZEUS BARBEQUE**

 Item: 70.500.20.0001
EAN: 8051085011391

 Item: 70.500.55.0001
EAN: 8051085011414

Size: 385 x 168 mm

Pcs/Master: 6



COC 02 COCOTTE

 Item: 24.002.86.0065 transp.
EAN: 8032539931311

Size: Ø 125 h 50 mm
Vol: 400ml
Pcs/Master: 3

COC 03 COCOTTE

 Item: 24.003.86.0065 transp.
EAN: 8032539931311

Size: Ø 185 h 65 mm
Vol: 1200ml
Pcs/Master: 3

COC 04 COCOTTE

 Item: 24.004.86.0065 transp.
EAN: 8032539931311

 Item: 24.004.98.0065
EAN: 8032539931342

Size: Ø 235 h 75 mm
Vol: 2200ml
Pcs/Master: 3



VAPO TWIST - S

Item: 72.032.23.0063
EAN: 8051085249824

Item: 72.032.93.0063
EAN: 8051085249848

Item: 72.032.61.0063
EAN: 8051085249800



Utilizzo: *How to use: | façon d'utiliser:*



Con tappo in polycarbonato
With polycarbonate top
Avec bouchon en polycarbonate



Con tappo scostato
With the polycarbonate top twisted
Avec bouchon déplacé



Senza tappo
Without the polycarbonate top
Sans bouchon

Size: Ø 220 mm
Pcs/Master: 4

VAPO TWIST È COMPOSTO DA:

- 1 coperchio Ø 220 mm
- 1 tappo rimovibile in polycarbonato

VAPO TWIST IS COMPOSED BY:

- 1 silicone cover Ø 8.66"
- 1 polycarbonate removable top

VAPO TWIST EST COMPOSÉ DE:

- 1 couvercle en silicone Ø 220 mm
- 1 bouchon amovible en polycarbonate

- Evita la dispersione di calore
- Evita la fuoriuscita della schiuma
- Flessibile nel tempo
- Cucina al vapore
- Ecologico
- Adatto alle alte temperature

- Avoids dispersion of heat
- Avoids the discharge of lather
- Flexible over time
- Steam cooking
- Ecologic
- Suitable for high temperatures

- Empêche la perte de la chaleur
- Empêche le débordement de la mousse
- Souple dans le temps
- Cuisine à la vapeur
- Éco-friendly
- Adaptés pour une utilisation avec des températures élevées

VAPO

Item: 72.030.19.0062
EAN: 8051085203802

Item: 72.030.41.0062
EAN: 8051085203826

Size: Ø 300 mm
Pcs/Master: 6

Coperchio, dotato di apposite fessure per permettere la fuoriuscita del vapore in fase di cottura. Utile anche per evitare la fuoriuscita della schiuma durante l'ebollizione.

Food grade silicone cover provided with special splits to allow the discharge of the steam during the cooking phase. It is also useful to avoid the discharge of lather during the boiling of water.

Couvercle en silicone alimentaire avec des fentes spéciales pour permettre à la vapeur de s'échapper pendant la cuisson. Également utile pour éviter que l'eau déborde pendant l'ébullition.



CAPFLEX RANGE

Elastico e lavabile in lavastoviglie, CAPFLEX è l'alternativa eco-friendly alla pellicola trasparente. Realizzato e disponibile nei diametri 40, 55, 80 e 105mm, questo pratico coperchio trasparente è ideale per conservare sottovuoto scodelle e contenitori e per preservare la freschezza e il sapore dei vostri cibi e bevande.

Elastic and washable in dishwasher, CAPFLEX is the eco-friendly alternative to the plastic wrap. Made of food safe silicone, it is available in 4 diameters: 40mm/1,57", 55mm/2,16", 80mm/3,14" and 105mm/4,13". This functional transparent silicone lid is perfect to vacuum-seal bowls and containers and preserve freshness and taste of your foods.

Élastique et lavable au lave-vaisselle, CAPFLEX est l'alternative écologique au film transparent. Fabriqué en silicone alimentaire et disponible dans les diamètres 40, 55, 80 et 105 mm, ce couvercle pratique en silicone transparent est idéal pour garder bols et récipients sous vide et pour préserver la fraîcheur et la saveur de vos aliments et boissons.

CAPFLEX 27X18



Item: 70.164.86.0065
EAN: 8051085306855

Size: 270 x 180 mm

Pcs/Master: 6



CAPFLEX S



Item: 25.028.90.0061
EAN: 8051085251803



Item: 25.028.91.0061
EAN: 8051085251827

Set 3 Pcs

Size: Ø 40 mm

Pcs/Master: 5



← Ø25/45mm →



CAPFLEX M

 Item: 25.029.90.0061
EAN: 8051085251728

 Item: 25.029.91.0061
EAN: 8051085251742

Set 2 Pcs | Size: Ø 55 mm

Pcs/Master: 5



← Ø45/65mm →



CAPFLEX L

 Item: 70.166.90.0061
EAN: 8051085251667

 Item: 70.166.91.0061
EAN: 8051085251643

Size: Ø 80 mm

Pcs/Master: 10



← Ø65/90mm →



CAPFLEX XL

 Item: 70.165.90.0061
EAN: 8051085251568

 Item: 70.165.91.0061
EAN: 8051085251582

Size: Ø 105 mm

Pcs/Master: 5



← Ø90/130mm →



CAPFLEX XXL

 Item: 70.169.90.0061
EAN: 8051085289493

 Item: 70.169.91.0061
EAN: 8051085289516

Size: Ø 160 mm

Pcs/Master: 5



← Ø160/224mm →



UFO RANGE

Conservare in modo appropriato gli alimenti è importantissimo, ecco perchè Silikomart ha concepito UFO: una coloratissima gamma di coperchi universali, perfetti per coprire e per conservare sottovuoto i vostri alimenti.

Store foods properly is very important, which is why Silikomart has conceived UFO: a colorful range of universal silicone lids, perfect to cover and to vacuum-seal your foods.

Bien conserver les aliments est très important, c'est pourquoi Silikomart a conçu UFO: une gamme colorée de couvercles universels en silicone, parfaits pour couvrir et conserver sous vide vos aliments.





UFO 10

 Item: 72.100.86.0062 transp.
EAN: 8051085023493
Size: Ø 105 mm | Pcs/Master: 6





UFO 15

 Item: 72.150.61.0062
EAN: 8051085021215
 Item: 72.150.86.0062 transp.
EAN: 8051085023509
Size: Ø 155 mm | Pcs/Master: 6



UFO 21

 Item: 72.210.81.0062
EAN: 8051085018208
 Item: 72.210.86.0062 transp.
EAN: 8051085021093
Size: Ø 215 mm | Pcs/Master: 3



UFO 25

 Item: 72.250.86.0062 transp.
EAN: 8051085021109
Size: Ø 255 mm | Pcs/Master: 3



UFO 29

 Item: 72.290.86.0062 transp.
EAN: 8051085021116
Size: Ø 295 mm | Pcs/Master: 3



UFO 34

 Item: 72.340.86.0062 transp.
EAN: 8051085029068
Size: Ø 340 mm | Pcs/Master: 3

IMB 01 IMBUTO

Item: 22.401.86.0062
 Size: 160 x 120 h 150 mm
 Volume: 300 ml
 Pcs/master: 3
 EAN: 8051085021574

**COC05 CUOCI MELA**

Item: 24.005.62.0065
 Size: Ø 115 h 115 mm
 Volume: 850 ml
 Pcs/master: 6
 EAN: 8051085028856

**SET LACCIO 55**

Set 3 Pcs
 Item: 25.411.24.0062
 Size: 550 mm
 Pcs/master: 3
 EAN: 8051085023462

**SET LACCIO 25**

Set 6 Pcs
 Item: 25.410.62.0062
 Size: 250 mm
 Pcs/master: 3
 EAN: 8051085021857





CRSP01 CRISPY MAT - BIG

Item: 23.025.85.0065
Size: 410 x 295 h 11 mm
Pcs/Master: 3
EAN: 8051085217229



CRSP02 CRISPY MAT - SMALL

Item: 23.026.01.0065
Size: 290 x 220 h 11 mm
Pcs/Master: 10
EAN: 8051085223558



KITCHEN PAD

Item: 23.028.72.0062
Size: 120 x 195 h 11 mm
Pcs/Master: 30
EAN: 8051085251490



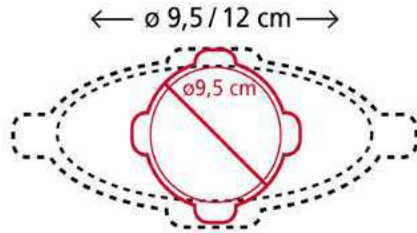

CFF 09B COVERFLEX

Item: 70.090.86.0696
 Size: Ø 90 mm
 Pcs/master: 12
 EAN: 8051085161607

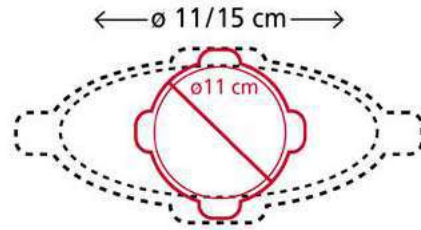

CFF 11B COVERFLEX

Item: 70.110.86.0696
 Size: Ø 110 mm
 Pcs/master: 12
 EAN: 8051085161621

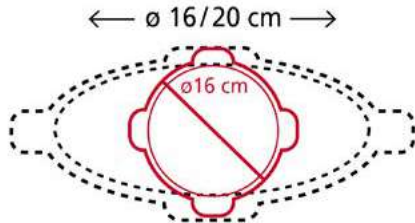

CFF 16B COVERFLEX

Item: 70.160.86.0696
 Size: Ø 160 mm
 Pcs/master: 12
 EAN: 8051085161645

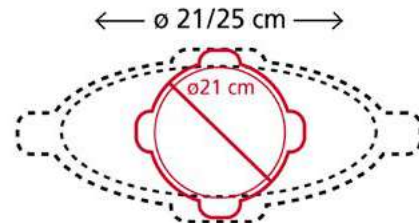

CFF 21B COVERFLEX

Item: 70.210.86.0696
 Size: Ø 210 mm
 Pcs/master: 12
 EAN: 8051085161669

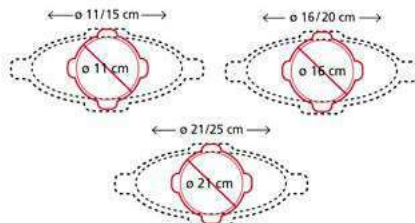

CFF SET3B COVERFLEX

Set 3 Pcs
 Item: 25.014.86.0096
 Size: Ø 110-160-210 mm
 Pcs/master: 12
 EAN: 8051085161683

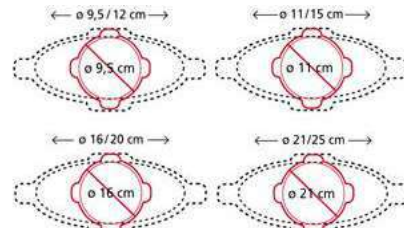

CFF SET4B COVERFLEX

Set 4 Pcs
 Item: 25.015.86.0096
 Size: Ø 90-110-160-210 mm
 Pcs/master: 12
 EAN: 8051085161706

3D Tree Choc	171	Bosco	77
Abbraccio	24	Botanica	74
ACC Mini Cookie Cutter	205	Bûche Coeur	45
ACC04 Mattarello	219	Bûche Lumière	46
ACC05 Mattarello	219	Bûche Quenelle	48
ACC077 Doppio Cuore	205	Bûche Sapin	47
ACC078 Orso	205	Bûche Snowy	45
ACC079 Star	172	Bunny 520	14
ACC097 Snow Man	172	Burger Bread	190
Aglio 4	81	Canestrello 15	90
Air Mat	160	Capflex	228
Airplus 02 Plum Cake	164	Caramellatore/Cannello	217
Airplus 03 Mini Plum Cake	164	Carciofo 28	80
Airplus 11 Éclair	167	Carota 20	84
Airplus 12 Round	165	Cerchio 3.0	93
Airplus 13 Round	164	Cerchio 4.0	93
Airplus 14 Round	164	Chablon bûche	29
Airplus 15 Round	165	Choco Angels	135
Airplus 16 Round	165	Choco Botton	135
Airplus 17 Square	166	Choco Crown	129
Airplus 18 Round	165	Choco Drop	128
Airplus 19 Square	166	Choco Egg	126
Airplus 20 Square	166	Choco Flame	128
Airplus 21 Triangle	166	Choco Friture	130
Amleto	127	Choco Frozen	136
Artic	48	Choco Fruits	135
Bacello 13	80	Choco Game	130
Bacio	24	Choco Goal	136
Bake'n'Roll	192	Choco Gufi	134
Bastoncini	184	Choco Keys	135
Bastoncini mini	185	Choco Macaron	134
Batticuore	21	Choco Melody	137
Bliss	28	Choco Pigs	136
Bocchette/Tubes	207	Choco Pine	137
Bolla B	111	Choco Spiral	128
Bolla P	111	Choco Spoon	135
Bolla T	111	Choco Springlife	134
Bolle	22	Choco Trees	127
Bollicine	40	Choco Winter	134

Chocogianduia	137	Dino	133
Christmas SCG06	132	Diva	179
CKC01 Snowman Slim	139	Dolce Tartufo	39
CKC02 Cookie Xmas Slim	139	Donuts	176
CKC04 Cookie Gnam Gnam Slim	139	Dot	21
CKC05 Cookie Dolce Vita Slim	140	Dreamy	46
CKC06 Cookie Love Slim	140	Dress	16
CKC12 Cookie Monsters Slim	140	Drippy	118
CKC14 Easter Slim	140	Easter Friends	135
Classic 3D	183	Easter SCG05	132
Classic Choco Bar	136	Easy Thermo	217
Coccola	39	Éclair & Choux Mat	161
Cocotte	226	Eclisse	15
Color	19	Eden	76
Cooling Grid	217	Egg Hunt	32
Corallo	49	Eleganza	25
Corona	75	Endless Love	17
Coverflex	233	Erbetta 43	88
Cream	36	Espogel Up Mini	187
Creative Xmas Countdown	170	Fairytale	13
Crispy Mat Big	232	Fantasia	134
Crispy Mat Small	232	Femore 32	87
Cubo	131	Fiberglass 5	159
Cucchiaio spatola ACC028	223	Fleury	132
Cuoci Mela COC05	231	Flower Power	28
Cuoricino	41	Focaccia Bread	190
Cup Decorative Spoon	170	Fogli Chitarra	114
Cup01 - Set 6 Pirottini	158	For You	193
Cupola B	104	Forchetta 2 rebbi	113
Cupola P	104	Forchetta 3 rebbi	113
Cupola T	104	Forchetta a spirale	113
Cutters for biscuits	218	Foresta	78
Cutting Rollers	219	Fragole E Panna	43
Decorative Spoon ACC099	170	Free Bake	176
Degusta 01 P	103	Frosty	120
Degusta 01 T	103	Frozen Bûche	51
Degusta 02 T	103	Frozen Bûche Mat	53
Delizia Al Limone	42	Funnel Choc	140
Diamond Bûche	50	Garden	29

Gel01 XXL	18	Kit Cubo 01	106
Gel01M Mini Classic	185	Kit Cuore 01	105
Gel03M Mini Heart-Ic	185	Kit Dome 01	99
Gel04M Mini Tango	185	Kit Ice Glow	49
Gel05M Mini Chic	185	Kit Magic Love	52
Gel10M Mini Vintage	185	Kit Magic Wood	52
Gemma	23	Kit Mini Tarte Glam	63
Gemma B	102	Kit Mini Tarte Petit Amour	61
Gemma P	102	Kit Mini Tarte Sand	63
Gemma T	102	Kit Mini Tarte Twist	63
Gift Box Creative Xmas Countdown	170	Kit Ovale 01	108
Gioia	24	Kit Pop Éclair	37
Girotondo	25	Kit Quadro 01	108
Goccia	22	Kit Semisfera 01	108
Goccia B	110	Kit Sinfonia B	106
Goccia P	110	Kit Sinfonia T	106
Goccia T	110	Kit Tarte Bsmboo	62
Gradual Bottles	217	Kit Tarte Grafique	60
Grippy	222	Kit Tarte Liberty	60
Heartbeat	16	Kit Tarte Meringué	61
Honoré	18	Kit Tarte Mon Amour	61
Ice Lolly	186	Kit Tarte Nouvelle Vague	62
Imbuto IMB01	231	Kitchen Pad	232
Imperial	131	Kono	134
Inserto Bûche & Cake	57	Lady Cocca	122
Intreccio	21	Lampo	76
Io & Te	23	Lana	48
Ispirazioni Di Frutta	43	Limone 14	82
Jack	132	Lisca 4	91
Kiss	126	Love Choco Bar	136
Kit Bar Duna	107	Love Story	15
Kit Bar Magma	100	Loving Birds	119
Kit Bar Sisma	100	Lucky Bunny	122
Kit Bar Tronco	107	Luna	23
Kit Bar Volta	107	Mac01 Macarons	159
Kit Bar Vulcano	100	Mac03 Heart	159
Kit Blocco B	105	Macaron Fiberglass 30x40	159
Kit Blocco T	105	Maggie	13
Kit Chic Éclair	37	Magic Bûche	51

Magic Bûche Mat	52	Onda P	109
Magic Love Mat	53	Onda T	109
Magic Wood Mat	53	Pannocchia 20	83
Martino	121	Passione	18
Mattarello Grande RP06	196	Paul Cino	122
Mattarello Mini RP05	196	Penna Decorativa 5 Punte	217
Mattarello Regolabile RP00	197	Pennelli	223
Maya Bûche	50	Peperoncino 13	83
Mela & Pera	74	Perla 20	25
Meringa	49	Perla 24	25
Michetta 92	87	Petal	33
Milanese 25	88	Piatto 80	75
Mini Baguette Bread	190	Piuma	77
Mini Color	35	Polpo 20	90
Mini Dot	35	Pomodorino 14	82
Mini Dress	34	Pomodoro 24	84
Mini Eleganza	42	Pops Stand	186
Mini Gemma	38	Porcino	86
Mini Girotondo	41	Praline SCG07	132
Mini Goccia	40	Precision Mat	197
Mini Intreccio	38	Presi ACC074	224
Mini Love Story	34	Primavera	24
Mini Puff	36	Profi Zeus Barbeque ACC082	225
Mini Raggio	39	Puff	35
Mini Wave	33	Pumpkin	121
Miss Hot ACC071	224	PVC Roll	217
Mister Hot ACC073	225	PVC Sheets	114
Modelling Tools	197	Quadrato 3.0	94
Moments	19	Quadrato 4.0	94
Monamour	131	Quadro	20
Mosaico	41	Raggio	22
Mr & Mrs Brown	127	Riga B	112
Mr Ginger	133	Riga P	112
Multi-inserito Round	56	Riga T	112
My Love	129	Roll Tool	197
Nature SCG10	133	Roller Dockers	219
Nest	118	Rose	133
Nuvola	17	Rosso Ciliegia	43
Onda B	109	Round 3D	182

Sandwich Bread	191	SF027 Petit-Fours	151
Sapin Magique	32	SF028 Cilindro	151
Scampo 20	91	SF029 Fiorentina	151
Scapers with handle	114	SF030 Fiorentina	151
Scraper	114	SF031 Madeleine	151
Secret Love	120	SF032 Madeleine	147
Segreti Del Bosco	42	SF033 Mini Cannelé	147
Set Decorative Spoon + Cup	170	SF034 Briochette	151
Set Gel01 Classic	184	SF035 Briochette	151
Set Gel02 Chocostick	184	SF039 Barchetta	151
Set Gel03 Heart-Ic	184	SF041 Mezzo Uovo	152
Set Gel04 Tango	184	SF043 Tortina	152
Set Laccio 25	231	SF047 Tortina	152
Set Laccio 55	231	SF048 Diamante	152
Set Sticks Easypop	186	SF050 Cannelé	147
SF001 Semisfera	149	SF051 Bavarese	152
SF002 Half Sphere	145	SF052 Muffin	152
SF003 Semisfera	149	SF054 Finanzieri	152
SF004 Semisfera	149	SF056 Margherita	152
SF005 Semisfera	149	SF057 Gugelhopf	152
SF006 Semisfera	145	SF058 Mini Gugelhupf	146
SF007 Piramidi	149	SF059 Midi Cannelé	147
SF008 Piramidi	149	SF061 Fantasy	153
SF009 Pomponette	149	SF074 Small Rose	177
SF010 Savarin	149	SF076 Sunflower	177
SF011 Savarin	149	SF077 Rose	177
SF012 Savarin	150	SF098 Cilindro	153
SF013 Tartelletta	150	SF100 Mini Pandoro	171
SF014 Tartelletta	150	SF102 Medium Muffin	153
SF015 Tartelletta	150	SF103 Savoiaro	153
SF016 Tartelletta	150	SF104 Cubi	153
SF019 Babà	150	SF104 Cubo	148
SF020 Babà	150	SF105 Cubo	148
SF021 Babà	150	SF106 Gingerbread Man	172
SF022 Mini Muffin	146	SF107 Stella	171
SF023 Muffin	146	SF108 Pino	171
SF024 Muffin	150	SF109 Mini Briochette	153
SF025 Finanzieri	151	SF110 Rettangolo	153
SF026 Mini Cake	146	SF117 Springlife	177

SF118 Tulip	178	SFT250 Gugelhupf	145
SF119 Cylinders	153	SFT251 Rose	178
SF127 Cylinders	153	SFT252 Girasole	179
SF129 Mini Buche	138	SFT300 Rettangolare	157
SF130 Midi Bûche	148	SFT303 Cathedral	179
SF131 Cono	154	SFT306 Quadrato	157
SF132 Mini Fantasy	177	SFT326 Plum Cake	156
SF135 Mini Springlife	177	SFT330 Plum Cake	145
SF151 Choco Flash	138	SFT331 Plum Cake	156
SF154 Charlotte	154	SFT332 Lasagnera	157
SF155 Waffel Classic	154	SFT336 Fairy Princess	179
SF158 Mini Vertigo	178	SFT424 Crostata	155
SF166 Magic Xmas	171	SFT426 Crostata	144
SF169 Choco ABC	138	SFT428 Crostata	155
SF173 Chocolat	139	SFT522 Brioche	157
SF174 Choco 123	138	SFT600 Meteor	178
SF176 Nigiri	154	Silicone Spatula	217
SF184 My Snack	138	Silicone Spoon	217
SF198 Winter Choco Tags	138	Silicopat	158
SF199 Funny Owls Choco Tags	139	SK3000 Uovo	141
SF201 Igloo	172	SK4000 Uovo	141
SF213 Choco Block	139	SLK	199
SF232 Mini Gugelhupf	154	Small Donuts	176
SFT Goleador	179	Small Total I-Gloo	187
SFT118	155	Smiling Eggs	121
SFT120	155	Smooth LIS01	196
SFT122	155	Snack'n'Roll	192
SFT124	155	Snowball	29
SFT126 Stampo Rotondo	144	Soffice Incanto	40
SFT128	155	Sottotorta quadrato	198
SFT180 Génoise	144	Sottotorta rotondo	198
SFT201 Etolie	172	Spatola grande ACC027	223
SFT203 Christmas Tree	172	Spatola piccola ACC026	223
SFT205 Ciambellone	144	Spatole 3pcs ACC029	223
SFT211 Love	179	Spatole angolari	113
SFT220 Margherita	157	Stainless Cake Tray	217
SFT224 Ciambella + anello	156	Starfish	137
SFT226	155	Starlight Bûche	51
SFT228 Pizza	157	Steel Spatula	114

Strudel Cutting	219	Xmas Choco Buttons	137
Surprise	193	Zeus ACC072	225
Sweet Treats	196		
Swing	38		
Tablette	133		
Tablette Choco Bar	136		
Tapis Roulade	158		
Tarte Ring Classic	60		
Tartufino	129		
Teatime	133		
Tesoro B	101		
Tesoro P	101		
Tesoro T	101		
Thermo Choc	140		
Tortellino 20	86		
Tower	20		
Treccia	191		
Triangolo 2.0	95		
Triangolo 3.0	95		
Ufo	230		
Vapo	227		
Vapo Twist S	227		
Vertigo	131		
Verza 12	81		
VGel03	187		
Vinile	20		
Voilà Cookie Leaves	67		
Voilà Cookie Love	69		
Voilà Cookie Winter Holiday	68		
Wave	14		
Whisk	217		
Winter Ball	126		
Winter Stars	137		
Winter Tree	119		
Winter Village	47		
WMat01 Pois	196		
WMat02 Matelassé	196		
Wonder Pops	196		
Wooly	19		



La nuovissima gamma alimentari per professionisti e amatori

*The brand new ingredients range
for professionals and amateurs*

*La toute nouvelle gamme d'ingrédients
pour professionnels et amateurs*



Tutto quello che può servire ad un pasticcere e ad un amatore con in più alcune novità imperdibili.

Dall'esperienza pluriennale di Silikomart, dal costante ascolto delle esigenze del mercato e dal confronto con i grandi protagonisti del settore nasce i78 – Ingredients by Silikomart, una linea di ingredienti e prodotti smart, specifici, innovativi e attentamente selezionati, in grado di mettere tutti d'accordo, professionisti pasticceri ma anche amatori e appassionati di pasticceria, nella preparazione di ogni tipo di ricetta, dalle più semplici fino alle più elaborate, con pochi e rapidi passaggi. I prodotti i78 – Ingredients by Silikomart sono il risultato di test rigorosi sviluppati presso il laboratorio di ricerca e innovazione hangar78. Prodotti per la decorazione, coloranti sintetici e naturali, preparati per dolci, additivi, paste concentrate: un universo completo di prodotti dedicati alla pasticceria, disponibili spesso in due size diverse, per soddisfare le esigenze di professionisti ma anche quelle degli amatori.

All that can be used by a pastry chef and an amateur with the addition of some unmissable news.

From the many years of Silikomart experience, from constant listening to the needs of the market and from the comparison with the major players in the sector, i78 - Ingredients by Silikomart is born, a line of smart, specific, innovative and carefully selected ingredients and products, able to all agree, professional pastry chefs but also amateurs and pastry enthusiasts, in the preparation of all types of recipes, from the simplest to the most elaborate, with a few quick steps. i78 - Ingredients by Silikomart products are the result of rigorous tests developed at the hangar78 research and innovation laboratory. Products for decoration, synthetic and natural colorants, cake mixes, additives, concentrated pastes: a complete universe of products dedicated to pastry, often available in two different sizes, to meet the needs of professionals but also those of amateurs.

Tout ce qui peut être utilisé par un pâtissier et un amateur avec en plus quelques nouveautés incontournables.

De la longue expérience de Silikomart, de l'écoute constante des besoins du marché et de la comparaison avec les principaux acteurs du secteur, naît i78 - Ingredients by Silikomart une gamme d'ingrédients et des produits smart, spécifiques, innovants et soigneusement sélectionnés, pouvant mettre tout le monde d'accord, pâtisseries professionnels mais aussi amateurs et passionnés de pâtisserie, dans la création de tous types de recettes, des plus simples aux plus élaborées, en quelques étapes rapides. Les produits i78 - Ingredients by Silikomart sont le résultat de tests rigoureux développés dans le laboratoire de recherche et d'innovation hangar78. Produits pour la décoration, colorants synthétiques et naturels, préparations pour confiseries, additifs, pâtes concentrées : un univers complet de produits dédiés à la pâtisserie, souvent déclinés en deux formats différents, pour répondre aux besoins des professionnels mais aussi à ceux des amateurs.



hangar78

FOOD & PASTRY EXPERIENCE



hangar78

Workshop

Corsi brevi di formazione che si concentrano su specifiche tematiche del mondo della pasticceria, della cucina e molto altro. I migliori professionisti del settore mettono a disposizione le proprie competenze e la loro esperienza per far apprendere tutte le sfaccettature dell'argomento affrontato.

Master online

Un percorso completo di formazione disponibile 24 ore su 24, 7 giorni su 7. Tutto quello che vuoi sapere sulla pasticceria, dalle basi fino alla più raffinata pasticceria italiana e francese, comodamente a casa tua. Creati con i più grandi esperti italiani e internazionali, danno la possibilità a chiunque di espandere le proprie potenzialità nel mondo della pasticceria. Sia per professionisti che per amatori.

Workshop online

Corsi di formazione online di pasticceria e cucina, per aggiornare le conoscenze su tematiche specifiche ed affinare le proprie tecniche. Ognuno può usufruirne liberamente dalla propria casa, laboratorio o anche regalare un'esperienza unica ad appassionati.

Perché scegliere hangar78

- I migliori insegnanti a livello nazionale ed internazionale
- Ampia selezione di corsi full time completi e corsi più brevi focalizzati su tematiche specifiche
- Posti limitati, per una formazione ed un supporto attento ad ogni singolo studente
- Consulenza su misura, con incontri 1to1 come aiuto nello sviluppo del proprio percorso nel mondo della pasticceria
- Struttura super moderna con singole postazioni e i migliori strumenti di lavoro
- Pagamenti rateizzati, con possibilità di personalizzazione



Scopri di più su
[hangar78.com](https://www.hangar78.com)

hangar78

Food and Pastry Innovation Lab.

Il laboratorio dei maestri pasticceri che dà forma al vostro talento.

È qui che nasce l'innovazione di Silikomart.

Dalla nostra fucina creativa di ricerca e sviluppo hangar78 vengono progettate, testate e sviluppate le nuove forme del pastry & food design in ogni loro espressione.

Dal laboratorio nasce la scuola di alta formazione creativa dove i risultati della ricerca vengono trasferiti a selezionati gruppi di allievi in workshop e master di pratica artigianale.

Con un'offerta formativa a 360°, rivolta sia ai professionisti che agli appassionati, hangar78 dispone di aule con attrezzature all'avanguardia dove poter assistere a lezioni e dimostrazioni e disporre di postazioni attrezzate con i più evoluti strumenti professionali.

Situata tra Padova e Venezia, la scuola di cucina e pasticceria hangar78 in poco tempo è diventata un punto di riferimento nel settore della formazione, con un'ampia offerta di corsi pratici e di aggiornamento dedicati al mondo del food.

Posta in un contesto contemporaneo, hangar78 è uno spazio culinario d'eccellenza in cui le idee si incontrano, si mescolano e si trasformano ispirando una crescita personale e professionale continua.

I valori di condivisione, apprendimento e convivialità si concretizzano nelle tre sale all'avanguardia che garantiscono un'esperienza completa.

La cooking arena, dedicata ai corsi di alta ristorazione, è una cucina professionale attrezzata, dotata di 35 comode sedute e maxi schermi per non perdere alcun dettaglio. La sala master, che ospita tutti i corsi pratici, è dotata di 16 postazioni di lavoro, ciascuna attrezzata come una vera e propria cucina, ed è munita di un sistema di videocamere per seguire i docenti in modo accurato. La cucina didattica è uno spazio dove esperti potranno divulgare e condividere le proprie competenze tecniche per corsi dimostrativi e di aggiornamento, ma all'occorrenza si trasforma in un laboratorio pratico di pasticceria, gelateria, panificazione e molto altro.



hangar78

Food and Pastry Innovation Lab.

The pastry chef lab that shapes your talent.

Silikomart's innovation starts here.

New pastry & food design shapes are designed, tested and developed in every expression at hangar78 creative lab of research and development.

The innovation lab inspires the creative advanced training school, where the research results are transferred to selected groups of students through workshops and masters of craft practice.

With a comprehensive training offer addressed to both professionals and pastry enthusiasts, hangar78 has classrooms with advanced equipment where one can attend lectures and demonstrations and have his/her own workstation equipped with the most advanced professional tools.

Located between Padua and Venice, the hangar78 cooking and pastry school has quickly become a reference point in the field of training, with a wide range of practical updating courses dedicated to the world of food.

Placed in a contemporary context, hangar78 is a culinary space of excellence in which ideas meet, mix and transform inspiring a continuous personal and professional growth.

The values of sharing and learning in a friendly atmosphere materialise in the three cutting-edge rooms that ensure a full experience.

The cooking arena, dedicated to haute cuisine courses, is a professional kitchen, equipped with 35 comfortable seats and maxi screens not to miss any details. The master room, which hosts all the practical courses, is provided with 16 workstations, each equipped as a real kitchen and with a camera system to accurately follow the lessons.

The didactic kitchen is a space where experts disseminate and share their technical skills for demonstration and updating courses, but if necessary it turns into a practical laboratory for pastry, ice cream, baking and much more.





Dove Siamo

Silikomart è in via Tagliamento 78 a Mellaredo di Pianiga in provincia di Venezia, dista 12 km dal vivace centro di Padova e 34 km da Venezia.

Silikomart

Via Tagliamento 78

30030 Mellaredo di Pianiga (VENEZIA) – ITALY

Coordinate GPS

45.465454, 9.18651599

Telefono: +39 041 5190550

ORARI DI SEGRETERIA

Dal Lunedì al Venerdì

MATTINO: dalle ore 9:00 alle ore 13:00

POMERIGGIO: dalle ore 14:00 alle ore 18:00

Sabato e festivi esclusi

ORARI SHOWROOM

Dal Lunedì al Venerdì

MATTINO: dalle ore 9:00 alle ore 13:00

POMERIGGIO: dalle ore 14:00 alle ore 17:00

Sabato e festivi esclusi

www.silikomart.com

FOLLOW US ON:



CERTIFICAZIONI:



COME ARRIVARE:

In Auto:

Se si arriva da MILANO

Uscita A4 PADOVA OVEST

Prendi l'uscita verso Tangenziale Nord

Segui le indicazioni per Centro Vigonza/Treviso

Se si arriva da BOLOGNA:

Uscita PADOVA SUD

Prendi l'uscita verso Milano/Tangenziale/Treviso/SS11/Venezia/Trento/Vicenza

Segui le indicazioni per Centro Vigonza/Treviso

Se si arriva da VENEZIA/MESTRE TRAMITE TANGENZIALE:

Entra in Tangenziale di Mestre

Prendi l'uscita Mirano-Dolo verso Mirano/Dolo

Prendi Via Noalese Sud/SR515

In treno:

Scendi alla stazione ferroviaria VIGONZA-PIANIGA

(arrivi circa ogni mezzora da Padova centrale o da Venezia Santa Lucia)

oppure scendi alla stazione ferroviaria PADOVA CENTRALE

Dalla stazione prendere un taxi oppure un autobus direzione TREVISO.

In autobus:

Da Stazione treni VIGONZA-PIANIGA:

Autobus linea direzione PIANIGA, ferma a MELLAREDO

zona industriale ogni 15 minuti circa.

Fermata Autobus più vicina 5 minuti a piedi da Hangar78.

Da stazione treni PADOVA CENTRALE:

Autobus di linea direzione TREVISO.

In Aereo:

Da Aeroporto Marco Polo a Venezia:

In auto: 35 minuti

In bus 1:40 h fino a Stazione Autobus / Stazione Ferroviaria

PADOVA CENTRALE (www.fsbusitalia.it)

Da aeroporto Antonio Canova a Treviso:

In auto: 55 minuti

Mezzi pubblici: Linea 6 ACTT fino a Stazione ferroviaria di Treviso – Treno

Treviso/Padova – Autobus da Padova Stazione Autobus a Pianiga

CATALOGUE 2024 - 2025

i78

Ingredients
by Silikomart

MADE IN ITALY



Tutto quello che può servire ad un pasticcere e ad un amatore con in più alcune novità imperdibili.

Dall'esperienza pluriennale di Silikomart, dal costante ascolto delle esigenze del mercato e dal confronto con i grandi protagonisti del settore nasce i78 – Ingredients by Silikomart, una linea di ingredienti e prodotti smart, specifici, innovativi e attentamente selezionati, in grado di mettere tutti d'accordo, professionisti pasticceri ma anche amatori e appassionati di pasticceria, nella preparazione di ogni tipo di ricetta, dalle più semplici fino alle più elaborate, con pochi e rapidi passaggi. Tutti i prodotti sono il risultato di test rigorosi sviluppati nel laboratorio di ricerca e innovazione hangar78. Prodotti per la decorazione, coloranti sintetici e naturali, preparati per dolci, additivi, paste concentrate: un universo completo di prodotti dedicati alla pasticceria, disponibili spesso in due size diverse, per soddisfare le esigenze di professionisti ma anche quelle degli amatori.

All that can be used by a pastry chef and an amateur with the addition of some unmissable news.

From the many years of Silikomart experience, from constant listening to the needs of the market and from the comparison with the major players in the sector, i78 - Ingredients by Silikomart is born, a line of smart, specific, innovative and carefully selected ingredients and products, able to all agree, professional pastry chefs but also amateurs and pastry enthusiasts, in the preparation of all types of recipes, from the simplest to the most elaborate, with a few quick steps. All products are the result of careful study and rigorous testing at the hangar78 research and innovation laboratory. Products for decoration, synthetic and natural colorants, cake mixes, additives, concentrated pastes: a complete universe of products dedicated to pastry, often available in two different sizes, to meet the needs of professionals but also those of amateurs.

Tout ce qui peut être utilisé par un pâtissier et un amateur avec en plus quelques nouveautés incontournables.

De la longue expérience de Silikomart, de l'écoute constante des besoins du marché et de la comparaison avec les principaux acteurs du secteur, naît i78 - Ingredients by Silikomart une gamme d'ingrédients et des produits smart, spécifiques, innovants et soigneusement sélectionnés, pouvant mettre tout le monde d'accord, pâtisseries professionnels mais aussi amateurs et passionnés de pâtisserie, dans la création de tous types de recettes, des plus simples aux plus élaborées, en quelques étapes rapides. Tous les produits sont le résultat d'une étude minutieuse et de tests rigoureux au laboratoire de recherche et d'innovation hangar78. Produits pour la décoration, colorants synthétiques et naturels, préparations pour confiseries, additifs, pâtes concentrées : un univers complet de produits dédiés à la pâtisserie, souvent déclinés en deux formats différents, pour répondre aux besoins des professionnels mais aussi à ceux des amateurs.



INDICE

i78

by Silikomart

INNOVATION

- pg. 04 THE ONE MIRROR GLAZE
- pg. 08 LIQUID SUGAR PASTE

INGREDIENTS

- pg. 12 CAKE MIX
- pg. 22 RAINBOW CAKE
- pg. 24 PASTE CONCENTRATE

DECORATION

- pg. 28 MIRROR GLAZE
- pg. 30 SUGAR PASTE
- pg. 34 NATURAL VELVET SPRAY
- pg. 35 VELVET SPRAY
- pg. 39 METALLIC SPRAY

COLORANTS

- pg. 42 NATURAL IDRO-LIPO COLOR & IDRO COLOR BOX
- pg. 44 NATURAL IDRO COLORS
- pg. 46 NATURAL LIPO COLORS
- pg. 50 IDRO COLORS
- pg. 52 LIPO COLORS
- pg. 54 PEARL COLOR
- pg. 55 DECORATIVE PENS
- pg. 56 GEL COLOR
- pg. 58 GLITTER DUST

COMMODITIES

- pg. 60 READY LACE
- pg. 62 COMMODITIES
- pg. 65 GOLD & SILVER SHEETS

i78
by Silikomart



Guarda il video
Watch the video
Regardez la vidéo

THE ONE MIRROR GLAZE

L'unico preparato per glassa a specchio in polvere che assicura gli stessi risultati di quella preparata a mano. Un unico prodotto per creare molteplici glasse. Facile da usare (è praticamente impossibile sbagliare), non richiede l'aggiunta di altri ingredienti ma solo acqua...più facile di così! Inoltre The One Mirror Glaze di i78 by Silikomart può essere aromatizzata con paste concentrate o cioccolato e colorata con coloranti idrosolubili (anche naturali). Disponibile in due formati: sachetto da 300g e da 1 kg per rispondere alle esigenze di tutti i consumatori. La glassa a specchio in polvere The One Mirror Glaze garantisce un risultato trasparente e brillante, che si mantiene anche a temperature negative.

The only powdered mirror glaze preparation that ensures the same results as the one prepared by hand. A single product to create multiple glazes. Easy to use (it is practically impossible to fail), it does not require the addition of other ingredients but only water... It can't get easier than that! Furthermore, The One Mirror Glaze by i78 by Silikomart can be flavored with concentrated or chocolate pastes and colored with water-soluble colorants (including natural ones). Available in two sizes: 300g and 1Kg bags to meet the needs of all consumers. The One Mirror Glaze powdered mirror glaze guarantees a transparent and shiny result, which is maintained even at negative temperatures.

Le glaçage unique! La seule préparation pour glaçage miroir en poudre qui assure les mêmes résultats que celle préparée à la main. Un seul produit pour créer plusieurs glaçages. Facile à utiliser (il est pratiquement impossible de se tromper), il ne nécessite pas l'ajout d'autres ingrédients mais uniquement de l'eau... plus simple que ça! De plus, The One Mirror Glaze de i78 by Silikomart peut être aromatisé avec des pâtes concentrées ou chocolat et coloré avec des colorants hydrosolubles (y compris naturels). Disponible en deux formats : sachet de 300g et de 1Kg pour répondre aux besoins de tous les consommateurs. Le glaçage miroir en poudre The One Mirror Glaze garantit un résultat transparent et brillant, qui se maintient même à des températures négatives.



THE ONE MIRROR GLAZE

Item: 99.523.02.0001
Size: 1Kg
Pcs/master: 3
EAN: 8051085370764



THE ONE MIRROR GLAZE

Item: 99.524.02.0001
Size: 300g
Pcs/master: 6
EAN: 8051085370788

I PLUS DI THE ONE MIRROR GLAZE DI I78 BY SILIKOMART

THE BENEFITS OF THE ONE MIRROR GLAZE BY i78 BY SILIKOMART

LES AVANTAGES DE THE ONE MIRROR GLAZE DE i78 BY SILIKOMART

- Facile da utilizzare
 - Versatile
 - Nessun ingrediente da aggiungere, solo acqua
 - Sarà sempre un successo
 - Personalizzabile in diversi colori
 - Si può aromatizzare con paste concentrate
 - Facile da conservare
 - Facile da dosare
 - Veloce da preparare
- Easy to use
 - Versatile
 - No ingredients to add, just water
 - Will always be a success
 - Customizable in different colors
 - It can be flavored with concentrated pastes
 - Easy to store
 - Easy to dose
 - Quick to prepare
- Facile à utiliser
 - Polyvalent
 - Aucun ingrédient à ajouter, juste de l'eau
 - Sera toujours un succès
 - Personnalisable en différentes couleurs
 - Il peut être aromatisé avec des pâtes concentrées
 - Facile à ranger
 - Facile à doser
 - Rapide à préparer

MODO D'USO

HOW TO USE - MODE D'EMPLOI

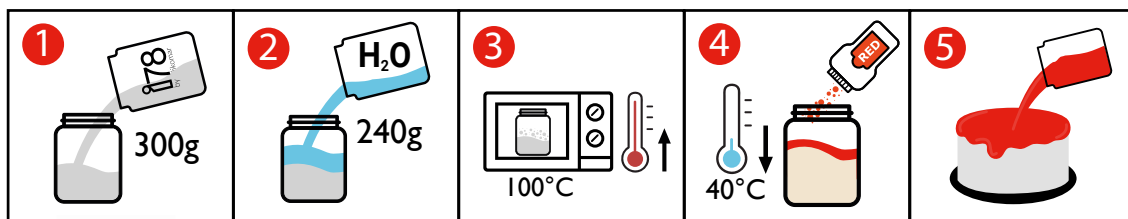

1. VERSA 300g di The One Mirror Glaze e 240g d'acqua.
2. MESCOLO con il frullatore ad immersione.
3. SCALDA fino ad ebollizione.
4. MESCOLO & COLORA.
5. UTILIZZA a 40°C su torte fredde, semifreddi, mousse, bavaresi.

1. POUR 300g of The One Mirror Glaze and 240g of water.
2. MIX with the hand blender.
3. HEAT until boiling.
4. MIX & COLOR.
5. USE at 40°C / 104°F on frozen cakes, semifreddo, mousses, bavarians.

1. VERSER 300g de The One Mirror Glaze et 240g d'eau.
2. MÉLANGER avec le mixeur plongeant.
3. CHAUFFER jusqu'à ébullition.
4. MÉLANGER & COLORER.
5. UTILISER à 40°C sur gâteaux froids, semifreddo, mousses, bavarois.



BEFORE



AFTER

i78

by Silikomart



Guarda il video
Watch the video
Regardez la vidéo

Liquid Sugar Paste di i78 è l'innovativa pasta di zucchero a colata. Quando si utilizza la classica pasta di zucchero da copertura è molto importante stenderla in modo uniforme, evitando antiestetiche grinze e senza lavorarla troppo perché diventerebbe appiccicosa e non liscia. Liquid Sugar Paste di i78 risponde a queste necessità: è un gel bianco pronto all'uso dalla consistenza densa che può essere colorato e aromatizzato secondo le proprie esigenze. In poche semplici mosse sarà possibile ricoprire in modo perfetto qualsiasi tipo di torta. Con il prodotto avanzato è possibile sia preparare della pasta di zucchero da modellaggio sia della crema al burro da decorazione.

Liquid Sugar Paste by i78 is the innovative pouring sugar paste. Using the classic sugar paste for cake coverage it is very important to spread it evenly, avoiding unsightly wrinkles and without working it too much because it would become sticky and not smooth. Liquid Sugar Paste by i78 meets these needs: it is a ready-to-use white gel with a thick consistency that can be colored and flavored according to your needs. In a few simple steps it will be possible to perfectly cover any kind of cake. With the leftover product it is possible to prepare both modeling sugar paste and decoration buttercream.

Liquid Sugar Paste de i78 est l'innovante pâte à sucre liquide. Lors de l'utilisation de la pâte à sucre classique pour le recouvrement, il est très important de l'étaler uniformément, en évitant les inesthétiques plis et sans trop la travailler car elle deviendrait collante et non lisse. Liquid Sugar Paste de i78 répond à ces besoins: c'est un gel blanc prêt à l'emploi de consistance épaisse qui peut être coloré et aromatisé selon vos besoins. En quelques étapes simples, il sera possible de recouvrir parfaitement tout type de gâteau. Avec le produit avancé, il est possible de préparer à la fois de la pâte à sucre à modeler et de la crème au beurre pour décoration.



LIQUID SUGAR PASTE (1KG)

Item: 99.521.02.0001

Size: 1kg

Pcs/master: 4

EAN: 8051085374632

LIQUID SUGAR PASTE (3KG)

Item: 99.522.01.0001

Size: 3kg

Pcs/master: 2

EAN: 8051085341306

I PLUS DI LIQUID SUGAR PASTE DI i78 BY SILIKOMART

THE BENEFITS OF LIQUID SUGAR PASTE BY i78 BY SILIKOMART

LES AVANTAGES DE LIQUID SUGAR PASTE DE i78 BY SILIKOMART

- | | | |
|---|--|--|
| <ul style="list-style-type: none"> · Molto facile da usare, molto più facile di una tradizionale pasta di zucchero · Non sono necessari strumenti per stenderla o livellarla · Molto molto più veloce di una pasta di zucchero tradizionale · Non si rompe e non si strappa · Può essere facilmente colorata con coloranti alimentari idrosolubili · Può essere aromatizzata con paste concentrate così ha un sapore migliore · Un unico prodotto per tante paste di zucchero diverse · Nessuno spreco · Non teme l'umidità · La torta si può conservare in frigo | <ul style="list-style-type: none"> · <i>Very easy to use, much easier than a traditional sugar paste</i> · <i>No tools required to spread it out or leveling it</i> · <i>Much much faster than a traditional sugar paste</i> · <i>Does not crack and tear</i> · <i>Can be easily colored with water-soluble food colorants</i> · <i>It can be flavored with concentrated pastes so it tastes better</i> · <i>One products for many many different sugar pastes</i> · <i>No waste</i> · <i>Does not fear humidity</i> · <i>The cake can be stored in the fridge</i> | <ul style="list-style-type: none"> · <i>Très simple à utiliser, bien plus simple qu'une pâte à sucre traditionnelle</i> · <i>Aucun outil nécessaire pour l'étaler ou la niveler</i> · <i>Beaucoup plus rapide qu'une pâte à sucre traditionnelle</i> · <i>Ne craque pas et ne se déchire pas</i> · <i>Peut être facilement coloré avec des colorants alimentaires hydrosolubles</i> · <i>Il peut être aromatisé avec des pâtes concentrées pour un meilleur goût</i> · <i>Un produit pour de nombreuses pâtes à sucre différentes</i> · <i>Pas de déchets</i> · <i>Ne craint pas l'humidité</i> · <i>Le gâteau peut être conservé au réfrigérateur</i> |
|---|--|--|

MODO D'USO

HOW TO USE - MODE D'EMPLOI

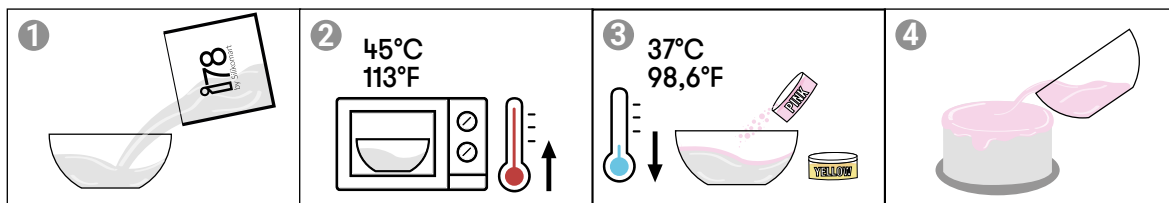

1. SCALDARE fino ad ottenere una consistenza fluida.
3. ABBASSARE la temperatura a 37°C.
4. COLARE sulla torta da rivestire.
5. ATTENDERE circa 1 ora che la pasta solidifichi.

1. HEAT until a fluid consistency is obtained.
3. LOWER the temperature to 37°C / 99°F.
4. POUR onto the cake to be coated.
5. WAIT about 1 hour for the paste to solidify.

1. CHAUFFER jusqu'à obtention d'une consistance fluide.
3. BAISSER la température à 37°C.
4. VERSER sur le gâteau à enrober.
5. ATTENDRE environ 1 heure que la pâte se solidifie.



BEFORE

- Super sottile
Super thin
Super fine
- Colorabile
Colorable
Colorable
- Aromatizzabile
Can be flavored
Peut être aromatisée
- Abbassa i tempi di lavorazione
It reduces processing times
Elle réduit les délais de travail
- Non teme l'umidità del frigorifero
It does not fear the humidity
of the refrigerator
Elle ne craint pas l'humidité
du réfrigérateur



AFTER

i78

by Silikomart



I PLUS DEI CAKE MIX i78 - THE BENEFITS OF THE i78 CAKE MIXES LES AVANTAGES DES PRÉPARATIONS EN POUVRE i78

La linea di cake mix i78, completamente gluten free, offre la possibilità ad amatori ed esperti di preparare in poco tempo dei dolci buoni e semplici da realizzare con ingredienti completamente made in Italy.

The i78 cake mix line, completely gluten free, offers amateurs and experts the possibility to prepare good and simple cakes in no time with completely made-in-Italy ingredients.

La gamme de préparations pour gâteaux i78, entièrement sans gluten, offre aux amateurs et aux experts la possibilité de préparer de bons gâteaux simples en un rien de temps avec des ingrédients entièrement fabriqués en Italie.



- Facile da usare
- Ingredienti di alta qualità
- Made in Italy
- Istruzioni chiare
- Facile senza glutine a casa
- Nessuna attrezzatura speciale necessaria
- Fa risparmiare tempo
- Nessuna esperienza di cottura necessaria
- Ampia scelta
- Traduzione in 6 lingue
- Adatto a tutta la famiglia

- Easy to use
- High quality ingredients
- Made in Italy
- Clear instructions
- Easy gluten free at home
- No special equipment needed
- Time saving
- No baking experience needed
- Wide choice
- Translation in 6 languages
- Suitable for the whole family

- Facile à utiliser
- Ingrédients de haute qualité
- Made in Italy
- Instructions claires
- Facile sans gluten à la maison
- Aucun équipement spécial nécessaire
- Un gain de temps
- Aucune expérience en pâtisserie requise
- Vaste choix
- Traduction en 6 langues
- Convient à toute la famille





BROWNIES

Item: 99.504.11.0062
 Size: 400g
 Pcs/master: 6
 EAN: 8051085370108



PREPARATO IN POLVERE PER BROWNIES
 POWDER MIX FOR BROWNIES
 PRÉPARATION EN POUDRE POUR BROWNIES



CREMA AL BURRO

Item: 99.504.25.0062
 Size: 200g
 Pcs/master: 6
 EAN: 8051085370269



PREPARATO IN POLVERE PER CREMA AL BURRO
 POWDER MIX FOR BUTTER CREAM
 PRÉPARATION EN POUDRE POUR CRÈME AU BEURRE



Usalo con:
 Combine with:
 Utiliser avec:



Coloranti in polvere
 Powder Colors
 Colorants en poudre

+



Paste concentrate
 Concentrated pastes
 Pâtes concentrées



FROSTING ALLA VANIGLIA

Item: 99.504.15.0062
 Size: 200g
 Pcs/master: 6
 EAN: 8051085370184



PREPARATO IN POLVERE PER FROSTING
 POWDER MIX FOR FROSTING
 PRÉPARATION EN POUDRE POUR FROSTING



Usalo con:
 Combine with:
 Utiliser avec:



Coloranti in polvere
 Powder Colors
 Colorants en poudre

+



Paste concentrate
 Concentrated pastes
 Pâtes concentrées



GHIACCIA REALE

Item: 99.504.16.0062
 Size: 200g
 Pcs/master: 6
 EAN: 8051085370207



PREPARATO IN POLVERE PER GHIACCIA REALE
 POWDER MIX FOR ROYAL ICING
 PRÉPARATION EN POUDRE POUR GLAÇAGE ROYALE



Usalo con:
 Combine with:
 Utiliser avec:



Coloranti in polvere
 Powder Colors
 Colorants en poudre



Paste concentrate
 Concentrated pastes
 Pâtes concentrées



MACARON - BIANCO

Item: 99.504.14.0062
 Size: 200g
 Pcs/master: 6
 EAN: 8051085370160



PREPARATO IN POLVERE PER MACARON - BIANCO
 POWDER MIX FOR MACARONS - WHITE
 PRÉPARATION EN POUDRE POUR MACARONS - BLANC



Usalo con:
 Combine with:
 Utiliser avec:



Coloranti in polvere
 Powder Colors
 Colorants en poudre



Paste concentrate
 Concentrated pastes
 Pâtes concentrées



RED VELVET

Item: 99.504.12.0062
 Size: 400g
 Pcs/master: 6
 EAN: 8051085370122



PREPARATO IN POLVERE PER RED VELVET
 POWDER MIX FOR RED VELVET CAKE
 PRÉPARATION EN POUDRE POUR RED VELVET



Usalo con:
 Combine with:
 Utiliser avec:



Coloranti in polvere
 Powder Colors
 Colorants en poudre



Paste concentrate
 Concentrated pastes
 Pâtes concentrées



MUFFIN & CUPCAKE AL CACAO

Item: 99.504.24.0062

Size: 400g

Pcs/master: 6

EAN: 8051085370245

NEW

PREPARATO IN POLVERE PER MUFFIN & CUPCAKES
POWDER MIX FOR MUFFIN & CUPCAKES
PRÉPARATION EN POUDRE POUR MUFFIN & CUPCAKES



PAN DI ZENZERO

Item: 99.504.13.0062

Size: 400g

Pcs/master: 6

EAN: 8051085370146

NEW

PREPARATO IN POLVERE PER PAN DI ZENZERO
POWDER MIX FOR GINGERBREAD COOKIES
PRÉPARATION EN POUDRE POUR PAIN D'ÉPICE



TORTA AL CACAO

Item: 99.504.23.0062

Size: 400g

Pcs/master: 6

EAN: 8051085370221

NEW

PREPARATO IN POLVERE PER TORTA AL CACAO
POWDER MIX FOR COCOA CAKE
PRÉPARATION EN POUDRE POUR GATEAU AU CACAO



TORTA ALLE MELE E CANNELLA

Item: 99.504.26.0062
 Size: 400g
 Pcs/master: 6
 EAN: 8051085370276



PREPARATO IN POLVERE PER TORTA ALLE MELE E CANNELLA
 POWDER MIX FOR APPLE AND CINNAMON CAKE
 PRÉPARATION EN POUDRE POUR GÂTEAU AUX



PAN DI SPAGNA

Item: 99.504.06.0062
 Size: 400g
 Pcs/master: 6
 EAN: 8051085341597



PREPARATO IN POLVERE PER PAN DI SPAGNA
 POWDER MIX FOR SPONGE CAKE
 PRÉPARATION EN POUDRE POUR GÉNOISE



Usalo con:
 Combine with:
 Utiliser avec:



Coloranti in polvere
 Powder Colors
 Colorants en poudre



Paste concentrate
 Concentrated pastes
 Pâtes concentrées



TORTA VANIGLIA

Item: 99.504.09.0062
 Size: 400g
 Pcs/master: 6
 EAN: 8051085341672



PREPARATO IN POLVERE PER TORTA VANIGLIA
 POWDER MIX FOR VANILLA FLAVORED CAKE
 PRÉPARATION EN POUDRE POUR GÂTEAU SAVEUR VANILLE



CUPCAKE & MUFFIN

Item: 99.504.03.0062
 Size: 400g
 Pcs/master: 6
 EAN: 8051085341535



PREPARATO IN POLVERE PER CUPCAKE & MUFFIN
 POWDER MIX FOR CUPCAKE & MUFFIN
 PRÉPARATION EN POUDRE POUR CUPCAKE & MUFFIN



Usalo con:
 Combine with:
 Utiliser avec:



Coloranti in polvere
 Powder Colors
 Colorants en poudre



Paste concentrate
 Concentrated pastes
 Pâtes concentrées

FROLLA & BISCOTTI

Item: 99.504.04.0062
 Size: 400g
 Pcs/master: 6
 EAN: 8051085341559



PREPARATO IN POLVERE PER FROLLA & BISCOTTI
 POWDER MIX FOR SHORTCRUST PASTRY AND COOKIES
 PRÉPARATION EN POUDRE POUR PÂTE BRISÉE ET DES BISCUIT



Usalo con :
 Combine with:
 Utiliser avec:



Coloranti in polvere
 Powder Colors
 Colorants en poudre



Paste concentrate
 Concentrated pastes
 Pâtes concentrées

TORTA ALLE MANDORLE E CAROTE

Item: 99.504.08.0062
 Size: 400g
 Pcs/master: 6
 EAN: 8051085341627



PREPARATO IN POLVERE PER
 TORTA ALLE MANDORLE E CAROTE
 POWDER MIX FOR ALMOND AND CARROT* CAKE
 PRÉPARATION EN POUDRE POUR
 GATEAU AUX AMANDES ET CAROTTES*



*ingrediente fresco da aggiungere, non contenuto nella confezione.
 *Fresh ingredient to add, not included in the package.
 *Ingrédient frais à ajouter, non inclus dans l'emballage.

ITEM	PALM OIL FREE	AZO FREE	E171 FREE	OGM FREE	GLUTEN FREE	VEGAN FRIENDLY
BROWNIES	●	●	●	●	●	
CREMA AL BURRO	●	●	●	●	●	
FROSTING ALLA VANIGLIA		●	●	●	●	
GHIACCIA REALE	●	●	●	●	●	●
MACARON BIANCO	●	●	●	●	●	
RED VELVET	●	●	●	●	●	
MUFFIN & CUPCAKE CACAO	●	●	●	●	●	
PAN DI ZENZERO	●	●	●	●	●	
TORTA AL CACAO	●	●	●	●	●	
TORTA MELE CANNELLA	●	●	●	●	●	
PAN DI SPAGNA	●	●	●	●	●	
TORTA VANIGLIA	●	●	●	●	●	
CUPCAKES & MUFFIN	●	●	●	●	●	
FROLLA & BISCOTTI	●	●	●	●	●	
TORTA MANDORLE E CAROTE	●	●	●	●	●	

i78
by Silikomart





i78
by Silikomart



TORTA ARCOBALENO

RAINBOW CAKE - RAINBOW CAKE

La rainbow cake, è una torta a piani coloratissima, davvero spettacolare in cui ogni strato ha un colore diverso fino a creare un arcobaleno farcito di golosa crema. I preparati in polvere i78 by Silikomart per rainbow cake sono pensati per permettere la massima personalizzazione del dolce: scegli singolarmente i colori e combinali come vuoi tu grazie alle pratiche confezioni singole da 100 grammi. Ogni confezione di preparato alimentare in polvere è pensato per la realizzazione di uno strato di torta rainbow cake del diametro di 22/24 cm.

The rainbow cake is a very colorful layer cake, truly spectacular, in which every layer has a different color to create a rainbow filled with delicious cream. The i78 by Silikomart powder mixes for rainbow cake are designed to allow maximum customization of the dessert: choose the colors individually and combine them as you wish thanks to the practical single 100-gram packs. Each pack of powdered food preparation is designed for making a Ø 22/24 cm layer of rainbow.

Le rainbow cake (gâteau arc-en-ciel) est un gâteau à plusieurs niveaux très coloré, vraiment spectaculaire dans lequel chaque couche a une couleur différente pour créer un arc-en-ciel qui peut être rempli de délicieuse crème. Les mélanges en poudre i78 by Silikomart pour rainbow cake sont conçus pour permettre une personnalisation maximale du dessert: choisissez les couleurs individuellement et combinez-les à votre guise grâce aux pratiques conditionnements individuels de 100 grammes. Chaque paquet de préparation alimentaire en poudre est conçu pour réaliser une couche de rainbow cake d'un diamètre de 22/24 cm.

PREPARATO PER IN POLVERE PER RAINBOW CAKE
POWDER MIX FOR RAINBOW CAKE
PRÉPARATION EN POUDRE POUR RAINBOWCAKE



RAINBOW CAKE - VERDE

Item: 99.504.21.0062
Size: 100g
Pcs/master: 8
EAN: 8051085370375



RAINBOW CAKE - ARANCIO

Item: 99.504.22.0062
Size: 100g
Pcs/master: 8
EAN: 8051085370399



RAINBOW CAKE - BLU

Item: 99.504.19.0062
Size: 100g
Pcs/master: 8
EAN: 8051085370337



RAINBOW CAKE - GIALLO

Item: 99.504.20.0062
Size: 100g
Pcs/master: 8
EAN: 8051085370351



RAINBOW CAKE - ROSSO

Item: 99.504.17.0062
Size: 100g
Pcs/master: 8
EAN: 8051085370290



RAINBOW CAKE - VIOLA

Item: 99.504.18.0062
Size: 100g
Pcs/master: 8
EAN: 8051085370313



i78

by Silikomart



PASTE CONCENTRATE

CONCENTRATED PASTES - PÂTES CONCENTRÉES

Paste aromatizzanti altamente concentrate da aggiungere a creme, impasti e gelati, ottime anche in cottura. Bastano pochi grammi per conferire l'aroma scelto alle vostre preparazioni. Semplicissime da usare, garantiscono un risultato professionale e sono perfette da usare con The One Mirror Glaze, Liquid Sugar Paste e Cake Mix. Disponibili in otto versioni: 100% nocciola, 99% pistacchio, gianduia, vaniglia, limone invernale, fragola, tiramisù e caramello salato.

Highly concentrated flavoring pastes to add to creams, doughs and ice creams, also excellent for baking. A few grams are enough to add the chosen aroma to your preparations. Extremely simple to use, they guarantee a professional result and are perfect to use with The One Mirror Glaze, Liquid Sugar Paste and Cake Mix. Available in eight versions: 100% hazelnut, 99% pistachio, gianduia, vanilla, winter lemon, strawberry, tiramisu and salted caramel.

Pâtes aromatisantes très concentrées à ajouter aux crèmes, pâtes et glaces, également excellentes pour la cuisson. Quelques grammes suffisent pour ajouter l'arôme choisi à vos préparations. Extrêmement simples à utiliser, ils garantissent un résultat professionnel et sont parfaits à utiliser avec The One Mirror Glaze, Liquid Sugar Paste et Cake Mix. Disponible en huit versions : 100% noisette, 99% pistache, gianduia, vanille, citron d'hiver, fraise, tiramisu et caramel salé.



PASTA AROMATIZZANTE NOCCIOLA 100%

FLAVOURING PASTE - HAZELNUT 100% | PÂTE AROMATISÉE - NOISETTE 100%

Item: 99.525.01.0001
Size: 150g
Pcs/master: 6
EAN: 8051085341320

PASTA AROMATIZZANTE GIANDUJA

FLAVOURING PASTE - GIANDUJA | PÂTE AROMATISÉE - GIANDUJA

Item: 99.525.02.0001
Size: 150g
Pcs/master: 6
EAN: 8051085341344



PASTA AROMATIZZANTE PISTACCHIO 99%

FLAVOURING PASTE - PISTACHIO 99% | PÂTE AROMATISÉE - PISTACHE 99%

Item: 99.525.03.0001
Size: 150g
Pcs/master: 6
EAN: 8051085341351

PASTA AROMATIZZANTE ALLA VANIGLIA

FLAVOURING PASTE - VANILLA | PÂTE AROMATISÉE - VANILLE

Item: 99.525.04.0001
Size: 150g
Pcs/master: 6
EAN: 8051085341368



PASTA AROMATIZZANTE LIMONE

FLAVOURING PASTE - LEMON 100% | PÂTE AROMATISÉE - CITRON 100%

Item: 99.525.07.0001
 Size: 150g
 Pcs/master: 6
 EAN: 8051085372027



PASTA AROMATIZZANTE FRAGOLA

FLAVOURING PASTE - STRAWBERRY | PÂTE AROMATISÉE - FRAISE

Item: 99.525.05.0001
 Size: 150g
 Pcs/master: 6
 EAN: 8051085372003



PASTA AROMATIZZANTE TIRAMISÙ

FLAVOURING PASTE - TIRAMISÙ | PÂTE AROMATISÉE - TIRAMISÙ

Item: 99.525.08.0001
 Size: 150g
 Pcs/master: 6
 EAN: 8051085372034



PASTA AROMATIZZANTE CARMELLO SALATO

FLAVOURING PASTE - CARAMEL | PÂTE AROMATISÉE - CARAMEL

Item: 99.525.06.0001
 Size: 150g
 Pcs/master: 6
 EAN: 8051085372010

ITEM	COLOR	AZO FREE	E171 FREE	OGM FREE	GLUTEN FREE	PALM OIL FREE
PASTA NOCCIOLA	●	●	●	●	●	●
PASTA GIANDUJA	●	●	●	●	●	●
PASTA PISTACCHIO	●	●	●	●	●	●
PASTA VANILLA	●	●	●	●	●	●
PASTA LIMONE	●	●	●	●	●	●
PASTA FRAGOLA	●	●	●	●	●	●
PASTA TIRAMISÙ	●	●	●	●	●	●
PASTA CARMELLO	●	●	●	●	●	●

i78
by Silikomart



i78

by Silikomart



GLASSA A SPECCHIO PRONTA ALL'USO**READY TO USE MIRROR GLAZE - GLAÇAGE MIROIR PRÊT À L'EMPLOI**

Glassa a specchio pronta all'uso. Perfetta per essere utilizzata come copertura di semifreddi, mousse, bavaresi e qualsiasi dessert freddo. La glassa è lucida, fluida e semplicissima da usare. È possibile colorare la glassa a specchio con coloranti alimentari in polvere o in gel.

Mirror glaze ready to use. It is perfect to be used as a cover for semifreddos, mousses, bavarian creams and any cold dessert. The glaze is glossy, fluid and super easy to use. You can color the mirror glaze with powdered or gel food coloring.

Glaçage miroir prêt à l'emploi. Parfait pour être utilisé comme couverture pour les semifreddos, les mousses, les crèmes bavaroises et tout dessert froid. Le glaçage est luisant, fluide et super facile à utiliser. Vous pouvez colorer le glaçage miroir avec du colorant alimentaire en poudre ou en gel.

**READY MADE MIRROR GLAZE RED**

Item: 99.505.05.0001
Size: 250g
Pcs/master: 6
EAN: 8051085339785

**READY MADE MIRROR GLAZE CHOCO**

Item: 99.505.03.0001
Size: 250g
Pcs/master: 6
EAN: 8051085339747

**READY MADE MIRROR GLAZE NEUTRAL**

Item: 99.505.00.0001
Size: 225g
Pcs/master: 6
EAN: 8051085339808



SUGAR PASTE

SUGAR PASTE - PÂTE À SUCRE

Pasta di Zucchero bianca e colorata senza olio di palma, disponibile in pratiche confezioni pronte all'uso.

Ideale per coprire torte di compleanno, torte da cerimonia e torte per ogni occasione, così come viene usata per decorare cupcake, cake pops e tante altre preparazioni. Ideale inoltre per modellare ogni tipo di decorazione.

White and colored sugar paste without palm oil, available in practical ready-to-use packaging. Ideal for covering birthday cakes, ceremony cakes and cakes for any occasion, as well as used to decorate cupcakes, cake pops and many other preparations. Also ideal for modeling any type of decoration.

Pâte à sucre blanche et colorée sans huile de palme, disponible en paquets pratiques prêts à l'emploi. Idéal pour recouvrir les gâteaux d'anniversaire, les gâteaux de cérémonie et les gâteaux de toutes occasions, ainsi que pour décorer les cupcakes, cake pops et bien d'autres préparations. Idéale également pour modeler tout type de décoration.





**SUGAR PASTE
BLACK**

Item: 99.501.01.0001
Size: 250g
Pcs/master: 8
EAN: 8051085333752



**SUGAR PASTE
BROWN COCOA**

Item: 99.501.15.0001
Size: 250g
Pcs/master: 8
EAN: 8051085369898



**SUGAR PASTE
DARK BLUE**

Item: 99.501.04.0001
Size: 250g
Pcs/master: 8
EAN: 8051085333899



**SUGAR PASTE
GREEN**

Item: 99.501.06.0001
Size: 250g
Pcs/master: 8
EAN: 8051085333875



**SUGAR PASTE
LIGHT BLUE**

Item: 99.501.08.0001
Size: 250g
Pcs/master: 8
EAN: 8051085333912



**SUGAR PASTE
PINK**

Item: 99.501.09.0001
Size: 250g
Pcs/master: 8
EAN: 8051085333936



**SUGAR PASTE
RED**

Item: 99.501.10.0001
Size: 250g
Pcs/master: 8
EAN: 8051085333950



**SUGAR PASTE
YELLOW**

Item: 99.501.13.0001
Size: 250g
Pcs/master: 8
EAN: 8051085333998



**SUGAR PASTE
ORANGE**

Item: 99.501.14.0001
Size: 250g
Pcs/master: 8
EAN: 8051085369881





**SUGAR PASTE
WHITE**

Item: 99.501.12.0001
Size: 250g
Pcs/master: 8
EAN: 8051085333974



**SUGAR PASTE 500 GR
WHITE**

Item: 99.502.01.0001
Size: 500g
Pcs/master: 4
EAN: 8051085345083



**SUGAR PASTE 1 KG
WHITE**

Item: 99.503.01.0001
Size: 1Kg
Pcs/master: 5
EAN: 8051085344253



**SUGAR PASTE 1 KG
BLACK**

Item: 99.503.03.0001
Size: 1Kg
Pcs/master: 5
EAN: 8051085369263



**SUGAR PASTE 1 KG
LIGHT BLUE**

Item: 99.503.05.0001
Size: 1Kg
Pcs/master: 5
EAN: 8051085369300



**SUGAR PASTE 1 KG
PINK**

Item: 99.503.04.0001
Size: 1Kg
Pcs/master: 5
EAN: 8051085369287



**SUGAR PASTE 1 KG
RED**

















































































Item: 99.503.02.0001
Size: 1Kg
Pcs/master: 5
EAN: 8051085369225



**SUGAR PASTE 5 KG
WHITE**

Item: 99.532.01.0001
Size: 5Kg
Pcs/master: 1
EAN: 8051085370092



ITEM	COLOR	AZO FREE	E171 FREE	PALM OIL FREE	GLUTEN FREE
SUGAR PASTE BLACK					
SUGAR PASTE BROWN COCOA					
SUGAR PASTE DARK BLUE					
SUGAR PASTE GREEN					
SUGAR PASTE LIGHT BLUE					
SUGAR PASTE PINK					
SUGAR PASTE RED					
SUGAR PASTE YELLOW					
SUGAR PASTE ORANGE					
SUGAR PASTE WHITE 250 GR					
SUGAR PASTE WHITE 500 GR					
SUGAR PASTE WHITE 1 KG					
SUGAR PASTE WHITE 5 KG					
SUGAR PASTE BLACK 1 KG					
SUGAR PASTE LIGHT BLUE 1 KG					
SUGAR PASTE PINK 1 KG					
SUGAR PASTE RED 1 KG					

Natural VELVET SPRAY

Colorante alimentare spray effetto velluto per decorare preparazioni congelate. Burro di cacao spray, perfetto per mousse, entremet e prodotti congelati in genere. Agitare bene prima e durante l'uso. Spruzzare uniformemente con piccole pressioni uno strato sottile ed omogeneo mantenendo una distanza di circa 25/30 cm dalla superficie congelata. Seguire attentamente le istruzioni riportate in etichetta.

Food grade velvet spray for the decoration of frozen preparations. Cocoa butter spray, perfect for mousses, entremets and frozen products in general. Shake well before and during using. Spray evenly with small pressures a thin and homogeneous layer keeping about 25/30 cm from the frozen surface. Carefully follow the instructions on the label.

Colorant alimentaire en spray à effet velours pour décorer les préparations congelées beurre de cacao en spray, parfait pour les mousses, les entremets et les produits surgelés en général. Bien agiter avant et pendant l'utilisation. Pulvériser uniformément avec de petites pressions une couche fine et homogène en gardant une distance d'environ 25/30 cm de la surface gelée. Suivre attentivement les instructions sur l'étiquette.



NATURAL VELVET SPRAY LIGHT BLUE

Item: 99.537.01.0001
Size: 250ml
Pcs/master: 6
EAN: 8051085377985



NATURAL VELVET SPRAY YELLOW

Item: 99.537.02.0001
Size: 250ml
Pcs/master: 6
EAN: 8051085378005



NATURAL VELVET SPRAY PINK

Item: 99.537.03.0001
Size: 250ml
Pcs/master: 6
EAN: 8051085378029



NATURAL VELVET SPRAY RED MAGENTA

Item: 99.537.04.0001
Size: 250ml
Pcs/master: 6
EAN: 8051085378043



NATURAL VELVET SPRAY GREEN

Item: 99.537.05.0001
Size: 250ml
Pcs/master: 6
EAN: 8051085378067



ITEM	COLOR	AZO FREE	E171 FREE	PALM OIL FREE	GLUTEN FREE
NATURAL VELVET SPRAY LIGHT BLUE					
NATURAL VELVET SPRAY YELLOW					
NATURAL VELVET SPRAY PINK					
NATURAL VELVET SPRAY RED MAGENTA					
NATURAL VELVET SPRAY GREEN					

VELVET SPRAY**VELVET SPRAY - VELVET SPRAY**

Colorante alimentare spray effetto velluto per decorare preparazioni congelate. Burro di cacao spray, perfetto per mousse, entremet e prodotti congelati in genere. Agitare bene prima e durante l'uso. Spruzzare uniformemente con piccole pressioni uno strato sottile ed omogeneo mantenendo una distanza di circa 50 cm dalla superficie congelata. Seguire attentamente le istruzioni riportate in etichetta.

Food grade velvet spray for the decoration of frozen preparations. Cocoa butter spray, perfect for mousses, entremets and frozen products in general. Shake well before and during using. Spray evenly with small pressures a thin and homogeneous layer keeping about 50 cm from the frozen surface. Carefully follow the instructions on the label.

Colorant alimentaire en spray à effet velours pour décorer les préparations congelées beurre de cacao en spray, parfait pour les mousses, les entremets et les produits surgelés en général. Bien agiter avant et pendant l'utilisation. Pulvériser uniformément avec de petites pressions une couche fine et homogène en gardant une distance d'environ 50 cm de la surface gelée. Suivre attentivement les instructions sur l'étiquette.

**VELVET SPRAY GOLD**

Item: 99.516.09.0001
Size: 250ml
Pcs/master: 6
EAN: 8051085338986

**VELVET SPRAY LIGHT BLUE**

Item: 99.516.10.0001
Size: 250ml
Pcs/master: 6
EAN: 8051085339006

**VELVET SPRAY ORANGE**

Item: 99.516.01.0001
Size: 250ml
Pcs/master: 6
EAN: 8051085338825

**VELVET SPRAY LIME**

Item: 99.516.11.0001
Size: 250ml
Pcs/master: 6
EAN: 8051085339020

**VELVET SPRAY LIGHT BROWN**

Item: 99.516.12.0001
Size: 250ml
Pcs/master: 6
EAN: 8051085339044

**VELVET SPRAY YELLOW**

Item: 99.516.03.0001
Size: 250ml
Pcs/master: 6
EAN: 8051085338863

**VELVET SPRAY CHERRY RED**

Item: 99.516.13.0001
Size: 250ml
Pcs/master: 6
EAN: 8051085339068

**VELVET SPRAY FUCSIA**

Item: 99.516.14.0001
Size: 250ml
Pcs/master: 6
EAN: 8051085339082

**VELVET SPRAY PINK**

Item: 99.516.05.0001
Size: 250ml
Pcs/master: 6
EAN: 8051085338900





VELVET SPRAY BUTTER WHITE

Item: 99.516.15.0001
 Size: 250ml
 Pcs/master: 6
 EAN: 8051085339105



VELVET SPRAY PURPLE

Item: 99.516.16.0001
 Size: 250ml
 Pcs/master: 6
 EAN: 8051085339129



VELVET SPRAY GREEN

Item: 99.516.07.0001
 Size: 250ml
 Pcs/master: 6
 EAN: 8051085338948



VELVET SPRAY WHITE

Item: 99.516.02.0001
 Size: 250ml
 Pcs/master: 6
 EAN: 8051085338849



VELVET SPRAY RED

Item: 99.516.06.0001
 Size: 250ml
 Pcs/master: 6
 EAN: 8051085338924



VELVET SPRAY BLACK

Item: 99.516.08.0001
 Size: 250ml
 Pcs/master: 6
 EAN: 8051085338962



VELVET SPRAY BROWN

Item: 99.516.04.0001
 Size: 250ml
 Pcs/master: 6
 EAN: 8051085338887



ITEM	COLOR	AZO FREE	E171 FREE	OGM FREE	GLUTEN FREE	PALM OIL FREE
VELVET SPRAY GOLD						
VELVET SPRAY LIGHT BLUE						
VELVET SPRAY ORANGE						
VELVET SPRAY LIME						
VELVET SPRAY LIGHT BROWN						
VELVET SPRAY YELLOW						
VELVET SPRAY CHERRY RED						
VELVET SPRAY FUCSIA						
VELVET SPRAY PINK						
VELVET SPRAY BUTTER WHITE						
VELVET SPRAY PURPLE						
VELVET SPRAY GREEN						
VELVET SPRAY WHITE						
VELVET SPRAY RED						
VELVET SPRAY BLACK						
VELVET SPRAY BROWN						



VELVET SPRAY GOLD

Item: 99.534.09.0001
Size: 400ml
Pcs/master: 9
EAN: 8051085373956



VELVET SPRAY LIGHT BLUE

Item: 99.534.10.0001
Size: 400ml
Pcs/master: 9
EAN: 8051085373970



VELVET SPRAY ORANGE

Item: 99.534.01.0001
Size: 400ml
Pcs/master: 9
EAN: 8051085373819



VELVET SPRAY LIME

Item: 99.534.11.0001
Size: 400ml
Pcs/master: 9
EAN: 8051085373994



VELVET SPRAY LIGHT BROWN

Item: 99.534.12.0001
Size: 400ml
Pcs/master: 9
EAN: 8051085374014



VELVET SPRAY YELLOW

Item: 99.534.03.0001
Size: 400ml
Pcs/master: 9
EAN: 8051085373833



VELVET SPRAY CHERRY RED

Item: 99.534.13.0001
Size: 400ml
Pcs/master: 9
EAN: 8051085374021



VELVET SPRAY FUCSIA

Item: 99.534.14.0001
Size: 400ml
Pcs/master: 9
EAN: 8051085374045



VELVET SPRAY PINK

Item: 99.534.05.0001
Size: 400ml
Pcs/master: 9
EAN: 8051085373871



VELVET SPRAY BUTTER WHITE

Item: 99.534.15.0001
Size: 400ml
Pcs/master: 9
EAN: 8051085374069



VELVET SPRAY PURPLE

Item: 99.534.16.0001
Size: 400ml
Pcs/master: 9
EAN: 8051085374083



VELVET SPRAY GREEN

Item: 99.534.07.0001
Size: 400ml
Pcs/master: 9
EAN: 8051085373918





VELVET SPRAY WHITE

Item: 99.534.02.0001
 Size: 400ml
 Pcs/master: 9
 EAN: 8051085373796



VELVET SPRAY RED

Item: 99.534.06.0001
 Size: 400ml
 Pcs/master: 9
 EAN: 8051085373895



VELVET SPRAY BLACK

Item: 99.534.08.0001
 Size: 400ml
 Pcs/master: 9
 EAN: 8051085373932



VELVET SPRAY BROWN

Item: 99.534.04.0001
 Size: 400ml
 Pcs/master: 9
 EAN: 8051085373857



ITEM	COLOR	AZO FREE	E171 FREE	OGM FREE	GLUTEN FREE	PALM OIL FREE
VELVET SPRAY GOLD						
VELVET SPRAY LIGHT BLUE						
VELVET SPRAY ORANGE						
VELVET SPRAY LIME						
VELVET SPRAY LIGHT BROWN						
VELVET SPRAY YELLOW						
VELVET SPRAY CHERRY RED						
VELVET SPRAY FUCSIA						
VELVET SPRAY PINK						
VELVET SPRAY BUTTER WHITE						
VELVET SPRAY PURPLE						
VELVET SPRAY GREEN						
VELVET SPRAY WHITE						
VELVET SPRAY RED						
VELVET SPRAY BLACK						
VELVET SPRAY BROWN						

METALLIC SPRAY

Colorante alimentare spray effetto metallizzato per decorare preparazioni congelate. Burro di cacao spray, perfetto per mousse, entremet e prodotti congelati in genere. Agitare bene prima e durante l'uso. Spruzzare uniformemente con piccole pressioni uno strato sottile ed omogeneo mantenendo una distanza di circa 25/30 cm dalla superficie congelata. Seguire attentamente le istruzioni riportate nell'etichetta.

Food grade metallic spray for the decoration of frozen preparations. Cocoa butter spray, perfect for mousses, entremets and frozen products in general. Shake well before and during using. Spray evenly with small pressures a thin and homogeneous layer keeping about 25/30 cm from the frozen surface. Carefully follow the instructions on the label.

Colorant alimentaire en spray à effet métallique pour décorer les préparations congelées beurre de cacao en spray, parfait pour les mousses, les entremets et les produits surgelés en général. Bien agiter avant et pendant l'utilisation. Pulvériser uniformément avec de petites pressions une couche fine et homogène en gardant une distance d'environ 25/30 cm de la surface gelée. Suivre attentivement les instructions sur l'étiquette.



METALLIC SPRAY GOLD











Item: 99.536.01.0001
Size: 250ml
Pcs/master: 6
EAN: 8051085377886



METALLIC SPRAY SILVER

Item: 99.536.02.0001
Size: 250ml
Pcs/master: 6
EAN: 8051085377909



ITEM	COLOR	AZO FREE	E171 FREE	PALM OIL FREE	GLUTEN FREE
METALLIC SPRAY GOLD					
METALLIC SPRAY SILVER					

i78

by Silikomart



COLORANTI NATURALI

NATURAL COLORS - COLORANTS NATURELS

I coloranti naturali i78 by Silikomart sono estratti vegetali da frutta e verdura con potere colorante. Non sono coloranti ma degli alimenti a tutti gli effetti! Sono particolarmente apprezzati per la loro facilità d'utilizzo, per la loro brillantezza e per le alte performance anche in cottura. Disponibili in versione idrosolubile (per meringhe, glasse e altre preparazioni a base d'acqua) e liposolubili (per cioccolato e preparazioni a base grassa).

The natural colors i78 by Silikomart are plant extracts from fruit and vegetables with coloring power. They are not colorants but food in all respects! They are particularly appreciated for their ease of use, for their brilliance and for their high performance even in baking. Available in water-soluble version (for meringues, icings and other water-based preparations) and fat-soluble (for chocolate and fat-based preparations).

Les colorants naturels de i78 by Silikomart sont des extraits végétaux de fruits et légumes avec pouvoir colorant. Ce ne sont pas des colorants mais des aliments à tous égards! Ils sont particulièrement appréciés pour leur facilité d'utilisation, pour leur brillance et pour leurs hautes performances même dans la préparation au four. Disponibles en version hydrosoluble (pour meringues, glaçages et autres préparations aqueuses) et liposoluble (pour chocolat et préparations grasses).



Natural IDRO COLOR

NATURAL IDRO COLOR - NATURAL IDRO COLOR - NATURAL IDRO COLOR

Preparazione alimentare in polvere, idrosolubile, con proprietà coloranti.

Water-soluble powdered food preparation with coloring properties.

Préparation alimentaire en poudre, soluble dans l'eau, avec propriétés colorantes.



NATURAL IDRO COLOR - YELLOW

Item: 99.512.01.0065

Size: 15g

Pcs/master: 12

EAN: 8051085374953



NEW FORMULA

NATURAL IDRO COLOR - RED

Item: 99.512.02.0065

Size: 15g

Pcs/master: 12

EAN: 8051085374977



NATURAL IDRO COLOR - PINK

Item: 99.512.03.0065

Size: 15g

Pcs/master: 12

EAN: 8051085374991



NATURAL IDRO COLOR - BLUE

Item: 99.512.04.0065

Size: 15g

Pcs/master: 12

EAN: 8051085375011



NATURAL IDRO COLOR - GREEN

Item: 99.512.05.0065

Size: 15g

Pcs/master: 12

EAN: 8051085375035



Natural LIPO COLOR

NATURAL LIPO COLOR - NATURAL LIPO COLOR - NATURAL LIPO COLOR

Preparazione alimentare in polvere, liposolubile, con proprietà coloranti.

Fat-soluble powdered food preparation with coloring properties.

Préparation alimentaire en poudre, liposoluble, avec propriétés colorantes.



NATURAL LIPO COLOR - YELLOW

Item: 99.514.01.0065

Size: 15g

Pcs/master: 12

EAN: 8051085375059



NATURAL LIPO COLOR - RED

Item: 99.514.02.0065

Size: 15g

Pcs/master: 12

EAN: 8051085375073





NATURAL LIPO COLOR - PINK

Item: 99.514.03.0065
 Size: 15g
 Pcs/master: 12
 EAN: 8051085375097



NATURAL LIPO COLOR - BLUE

Item: 99.514.04.0065
 Size: 15g
 Pcs/master: 12
 EAN: 8051085375110



NATURAL LIPO COLOR - GREEN

Item: 99.514.05.0065
 Size: 15g
 Pcs/master: 12
 EAN: 8051085375134



IDRO COLOR - IDRO COLOR - IDRO COLOR

Colorante alimentare in polvere

Idrosolubilewater-soluble food colouring powder

Colorant alimentaire hydrosoluble en poudre



IDRO COLOR - ORANGE

Item: 99.509.01.0095
 Size: 5g
 Pcs/master: 12
 EAN: 8051085374939



IDRO COLOR - YELLOW

Item: 99.509.03.0095
 Size: 5g
 Pcs/master: 12
 EAN: 8051085374854



IDRO COLOR - BLUE

Item: 99.509.02.0095
 Size: 5g
 Pcs/master: 12
 EAN: 8051085374830



IDRO COLOR - BROWN

Item: 99.509.04.0095
 Size: 5g
 Pcs/master: 12
 EAN: 8051085374878



IDRO COLOR - RED

Item: 99.509.05.0095
 Size: 5g
 Pcs/master: 12
 EAN: 8051085374892



IDRO COLOR - GREEN

Item: 99.509.06.0095
 Size: 5g
 Pcs/master: 12
 EAN: 8051085374915



NEW SIZE NATURAL IDRO COLOR - NATURAL IDRO COLOR - NATURAL IDRO COLOR

Preparazione alimentare in polvere, idrosolubile, con proprietà coloranti.

Water-soluble powdered food preparation with coloring properties.

Préparation alimentaire en poudre, soluble dans l'eau, avec propriétés colorantes.



NATURAL IDRO COLOR - YELLOW

Item: 99.513.01.0005

Size: 25g

Pcs/master: 6

EAN: 8051085375189



NATURAL IDRO COLOR - RED

Item: 99.513.02.0005

Size: 25g

Pcs/master: 6

EAN: 8051085375165



NATURAL IDRO COLOR - PINK

Item: 99.513.03.0005

Size: 25g

Pcs/master: 6

EAN: 8051085375202



NATURAL IDRO COLOR - BLUE

Item: 99.513.04.0005

Size: 25g

Pcs/master: 6

EAN: 8051085375226



NATURAL IDRO COLOR - GREEN

Item: 99.513.05.0005

Size: 25g

Pcs/master: 6

EAN: 8051085375387



ALTAMENTE CONCENTRATI - HIGHLY CONCENTRATED - HAUTEMENT CONCENTRÉ

Torta
Cake / Gâteau



Dosage: 3,5g/Kg

Meringa
Meringue / Meringue



Dosage: 7,0g/Kg

Cremoso
Cream / Crémeux



Dosage: 5,0g/Kg

Gelato
Ice-cream / Crème glacée



Dosage: 2,0g/Kg

Glassa
Glaze / Glaçage



Dosage: 6,67g/Kg



Dosage: 2,0g/Kg



Dosage: 3,34g/Kg



Dosage: 10,0g/Kg



Dosage: 2,0g/Kg



Dosage: 2,67g/Kg



Dosage: 3,5g/Kg



Dosage: 3,34g/Kg



Dosage: 10,0g/Kg



Dosage: 2,0g/Kg



Dosage: 4,67g/Kg



Dosage: 15,0g/Kg



Dosage: 10,0g/Kg



Dosage: 10,0g/Kg



Dosage: 5,0g/Kg



Dosage: 13,34g/Kg



Dosage: 6,5g/Kg



Dosage: 10,0g/Kg



Dosage: 10,0g/Kg



Dosage: 4,0g/Kg



Dosage: 6,67g/Kg

NATURAL LIPO COLOR - NATURAL LIPO COLOR - NATURAL LIPO COLOR

Preparazione alimentare in polvere, liposolubile, con proprietà coloranti.
Fat-soluble powdered food preparation with coloring properties.
Préparation alimentaire en poudre, liposoluble, avec propriétés colorantes.

Cioccolato
Chocolat / Chocolat



NATURAL LIPO COLOR - YELLOW

Item: 99.515.01.0005
 Size: 25g
 Pcs/master: 6
 EAN: 8051085375264



Dosage: 20,0g/Kg



NATURAL LIPO COLOR - RED

Item: 99.515.02.0005
 Size: 25g
 Pcs/master: 6
 EAN: 8051085375288



Dosage: 30,0g/Kg



NATURAL LIPO COLOR - PINK

Item: 99.515.03.0005
 Size: 25g
 Pcs/master: 6
 EAN: 8051085375301



Dosage: 20,0g/Kg



NATURAL LIPO COLOR - BLUE

Item: 99.515.04.0005
 Size: 25g
 Pcs/master: 6
 EAN: 8051085375363



Dosage: 30,0g/Kg



























































NATURAL LIPO COLOR - GREEN

Item: 99.515.05.0005
 Size: 25g
 Pcs/master: 6
 EAN: 8051085375349



Dosage: 20,0g/Kg



ITEM	COLOR	AZO FREE	E171 FREE	OGM FREE	GLUTEN FREE	VEGAN FRIENDLY
NATURAL IDRO YELLOW						
NATURAL IDRO RED						
NATURAL IDRO PINK						
NATURAL IDRO BLUE						
NATURAL IDRO GREEN						
NATURAL LIPO YELLOW						
NATURAL LIPO RED						
NATURAL LIPO PINK						
NATURAL LIPO BLUE						
NATURAL LIPO GREEN						



i78
by Silikomart

i78
by Silikomart



COLORANTI IN POLVERE

POWDERED COLORS - COLORANTS EN POUDRE

I Coloranti alimentari idrosolubili e liposolubili in polvere sono ad alta concentrazione e ad alto potere di pigmentazione. Grazie all'alta qualità del colorante, sarà sufficiente una piccolissima quantità per colorare paste di zucchero, marzapane, glassa, meringa, cioccolato, mousse, glasse e molto altro.

The water-soluble and fat-soluble food colors in powder are highly concentrated and they have a high pigmentation power. Thanks to the high quality of the product, a very small amount will be sufficient to color sugar paste, marzipan, icing, meringue, chocolate, mousse, icing and much more.

Les colorants alimentaires en poudre hydrosolubles et liposolubles sont très concentrés et ont un haut pouvoir pigmentant. Grâce à la haute qualité du colorant, une très petite quantité suffira pour colorer la pâte à sucre, la pâte d'amande, le glaçage, la meringue, le chocolat, la mousse, le glaçage et bien plus encore.



IDRO COLOR - IDRO COLOR - IDRO COLOR

Colorante alimentare in polvere

Idrosolubilewater-soluble food colouring powder

Colorant alimentaire hydrosoluble en poudre



IDRO COLOR - ORANGE

Item: 99.508.01.0001

Size: 25g

Pcs/master: 6

EAN: 8051085343201



IDRO COLOR - BLUE

Item: 99.508.02.0001

Size: 25g

Pcs/master: 6

EAN: 8051085343225



IDRO COLOR - YELLOW

Item: 99.508.03.0001

Size: 25g

Pcs/master: 6

EAN: 8051085343249



IDRO COLOR - BROWN

Item: 99.508.04.0001

Size: 25g

Pcs/master: 6

EAN: 8051085343263



IDRO COLOR - RED

Item: 99.508.05.0001

Size: 25g

Pcs/master: 6

EAN: 8051085343287



IDRO COLOR - GREEN

Item: 99.508.06.0001

Size: 25g

Pcs/master: 6

EAN: 8051085343300



Torta
Cake / Gâteau



Dosage: 0,04g/Kg

Meringa
Meringue / Meringue



Dosage: 0,33g/Kg

Cremoso
Cream / Crémeux



Dosage: 0,04g/Kg

Gelato
Ice-cream / Crème glacée



Dosage: 0,04g/Kg

Glassa
Glaze / Glaçage



Dosage: 0,04g/Kg



Dosage: 0,55g/Kg



Dosage: 0,50g/Kg



Dosage: 0,1g/Kg



Dosage: 0,2g/Kg



Dosage: 0,53g/Kg



Dosage: 0,55g/Kg



Dosage: 0,53g/Kg



Dosage: 0,2g/Kg



Dosage: 0,34g/Kg



Dosage: 0,53g/Kg



Dosage: 0,70g/Kg



Dosage: 0,70g/Kg



Dosage: 0,2g/Kg



Dosage: 0,5g/Kg



Dosage: 0,54g/Kg



Dosage: 0,55g/Kg



Dosage: 0,53g/Kg



Dosage: 0,04g/Kg



Dosage: 0,5g/Kg



Dosage: 0,53g/Kg



Dosage: 0,55g/Kg



Dosage: 0,50g/Kg



Dosage: 0,1g/Kg



Dosage: 0,3g/Kg



Dosage: 5,34g/Kg

LIPO COLOR - LIPO COLOR - LIPO COLOR

Colorante alimentare liposolubile in polvere

Liposoluble food colouring powder

Colorant alimentaire liposoluble en poudre



LIPO COLOR - ORANGE

Item: 99.510.01.0001

Size: 20g

Pcs/master: 6

EAN: 8051085343430



Cioccolato

Chocolate / Chocolat



Dosage: 0,1g/Kg



LIPO COLOR - BLUE

Item: 99.510.02.0001

Size: 20g

Pcs/master: 6

EAN: 8051085343478



Dosage: 1,9g/Kg



LIPO COLOR - YELLOW

Item: 99.510.03.0001

Size: 20g

Pcs/master: 6

EAN: 8051085343492



Dosage: 1,2g/Kg



LIPO COLOR - BROWN

Item: 99.510.04.0001

Size: 20g

Pcs/master: 6

EAN: 8051085343454



Dosage: 0,5g/Kg



LIPO COLOR - WHITE

Item: 99.510.09.0001

Size: 20g

Pcs/master: 6

EAN: 8051085364855



Ciocolato

Chocolate / Chocolat



Dosage: 10,0g/Kg



LIPO COLOR - RED

Item: 99.510.06.0001

Size: 20g

Pcs/master: 6

EAN: 8051085343539



Dosage: 1,6g/Kg



LIPO COLOR - GREEN

Item: 99.510.07.0001

Size: 20g

Pcs/master: 6

EAN: 8051085343553



Dosage: 1,6g/Kg



LIPO COLOR - BLACK

Item: 99.510.08.0001

Size: 20g

Pcs/master: 6

EAN: 8051085343676



Dosage: 14,0g/Kg

PEARL COLOR - PEARL COLOR - PEARL COLOR

Colorante alimentare perlato in polvere
 Pearly food colouring powder
 Colorant alimentaire perlé en poudre



PEARL COLOR - COPPER

Item: 99.511.02.0001
 Size: 20g
 Pcs/master: 6
 EAN: 8051085343591



PEARL COLOR - GOLD





















































































Item: 99.511.05.0001
 Size: 20g
 Pcs/master: 6
 EAN: 8051085364893



PEARL COLOR - RED

Item: 99.511.04.0001
 Size: 20g
 Pcs/master: 6
 EAN: 8051085343638



ITEM	COLOR	AZO FREE	E171 FREE	OGM FREE	GLUTEN FREE
IDRO COLOR ORANGE					
IDRO COLOR BLUE					
IDRO COLOR YELLOW					
IDRO COLOR BROWN					
IDRO COLOR RED					
IDRO COLOR GREEN					
LIPO COLOR ORANGE					
LIPO COLOR BLUE					
LIPO COLOR YELLOW					
LIPO COLOR BROWN					
LIPO COLOR WHITE					
LIPO COLOR RED					
LIPO COLOR GREEN					
LIPO COLOR BLACK					
PEARL COLOR COPPER					
PEARL COLOR GOLD					
PEARL COLOR RED					

PENNARELLI PER DECORARE ALIMENTI
DECORATIVE PENS FOR DECORATING FOOD
STYLO DÉCORATIFS POUR DÉCORER LES ALIMENTS

Pennarelli alimentari pronti all'uso a punta fine per disegnare o scrivere su pasta di zucchero, cioccolato plastico, fogli di glassa e fogli di ostia.

Ready-to-use food markers with fine tip for drawing or writing on sugar paste, plastic chocolate, icing sheets and wafer sheets.

Marqueurs alimentaires prêts à l'emploi à pointe fine pour dessiner ou écrire sur pâte à sucre, chocolat plastique, feuilles de glaçage et feuilles d'azyme.



DECORATIVE PENS

Item: 99.538.01.0065
 EAN: 8051085378197



DOUBLE DECORATIVE PEN

Item: 99.519.01.0001
 Color: Black
 Pcs/master: 40
 EAN: 8051085344291



COLORANTI ALIMENTARI IN GEL GEL FOOD COLOURS - COLORANTS ALIMENTAIRES EN GEL

Colorante concentrato in gel. Ideale per la colorazione in massa di: pasta di zucchero, prodotti da forno, panna e glasse.

Concentrated gel colouring. Ideal for colouring the surface of sugar paste, bakery product, cream and glazes.

Colorant concentré en gel. Idéal pour la coloration en masse de: pâte à sucre, produits de pâtisserie et boulangerie, crèmes et glaçages.





GEL COLOR ORANGE

Item: 99.506.01.0001
 Size: 15g
 Pcs/master: 12
 EAN: 8051085339150



GEL COLOR LIGHT BLUE

Item: 99.506.02.0001
 Size: 15g
 Pcs/master: 12
 EAN: 8051085339181



GEL COLOR RED

Item: 99.506.06.0001
 Size: 15g
 Pcs/master: 12
 EAN: 8051085339303



GEL COLOR YELLOW

Item: 99.506.03.0001
 Size: 15g
 Pcs/master: 12
 EAN: 8051085339211



GEL COLOR BLACK

Item: 99.506.04.0001
 Size: 15g
 Pcs/master: 12
 EAN: 8051085339242



GEL COLOR PINK

Item: 99.506.05.0001
 Size: 15g
 Pcs/master: 12
 EAN: 8051085339273



GEL COLOR GREEN

Item: 99.506.07.0001
 Size: 15g
 Pcs/master: 12
 EAN: 8051085339334



GEL COLOR PURPLE

Item: 99.506.08.0001
 Size: 15g
 Pcs/master: 12
 EAN: 8051085339365



ITEM	COLOR	AZO FREE	E171 FREE	OGM FREE	GLUTEN FREE	VEGAN FRIENDLY
GEL COLOR ORANGE						
GEL COLOR LIGHT BLUE						
GEL COLOR RED						
GEL COLOR YELLOW						
GEL COLOR BLACK						
GEL COLOR PINK						
GEL COLOR GREEN						
GEL COLOR PURPLE						



GLITTER DUST POLVERE SCINTILLANTE EXTRA FINE
EXTRA FINE GLITTERING POWDER - POUFRE SCINTILLANTE EXTRAFINE

Miscela di coloranti perlescente, in polvere, per uso alimentare con pompetta ad aria, ideale per decorazioni e per la colorazione in superficie di: prodotti a base di zucchero, cioccolato, crema al burro, meringhe, masse grasse in generale.

Mixture of foodgrade pearlescent powdered colors, with an air pump, ideal for decorations and for coloring the surface of: sugar-based products, chocolate, butter cream, meringues, fatty masses in general.

Mélange de colorants nacrés, en poudre, à usage alimentaire avec une pompe à air, idéal pour les décorations et pour colorer la surface de: produits à base de sucre, chocolat, crème au beurre, meringues, masses grasses en général.



GLITTER DUST SILVER

Item: 99.507.09.0001
 Size: 10g
 Pcs/master: 6
 EAN: 8051085364190

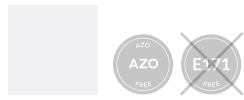

GLITTER DUST BRONZE

Item: 99.507.02.0001
 Size: 10g
 Pcs/master: 6
 EAN: 8051085339440



GLITTER DUST PINK

Item: 99.507.12.0001
 Size: 10g
 Pcs/master: 6
 EAN: 8051085364299



GLITTER DUST GOLD

Item: 99.507.10.0001
 Size: 10g
 Pcs/master: 6
 EAN: 8051085364251



GLITTER DUST RED

Item: 99.507.04.0001
 Size: 10g
 Pcs/master: 6
 EAN: 8051085339501



GLITTER DUST GREEN*

Item: 99.507.13.0001
 Size: 10g
 Pcs/master: 6
 EAN: 8051085364329



**Attualmente non disponibile
 Currently not available
 Actuellement indisponible*



GLITTER DUST LIGHT BLUE









































Item: 99.507.14.0001
 Size: 10g
 Pcs/master: 6
 EAN: 8051085364350



GLITTER DUST YELLOW

Item: 99.507.11.0001
 Size: 10g
 Pcs/master: 6
 EAN: 8051085364268



ITEM	COLOR	AZO FREE	E171 FREE	OGM FREE	GLUTEN FREE
GLITTER SILVER					
GLITTER BRONZE					
GLITTER PINK					
GLITTER GOLD					
GLITTER RED					
GLITTER GREEN					
GLITTER LIGHT BLUE					
GLITTER YELLOW					



READY LACE - READY LACE - READY LACE

GEL ALIMENTARE SENZA GLUTINE PRONTO ALL'USO PER CREARE PIZZI PERFETTI ED ELASTICI E ALTRE DECORAZIONI PER TORTE.

Ready Lace è un gel colorabile per la realizzazione di bellissimi pizzi in zucchero per decorare torte, biscotti ecc. Semplicissimo da utilizzare, permette di decorare torte e dessert attraverso un vero effetto tridimensionale. Disponibile in due formati: 140g e 520g.

EDIBLE GLUTENFREE GEL READY-TO-USE TO CREATE PERFECT AND ELASTIC LACES AND OTHER CAKE DECORATIONS.

Ready Lace is a colorable gel for making beautiful sugar lace to decorate cakes, biscuits, etc. Extremely simple to use, it allows you to decorate cakes and desserts with a true three-dimensional effect. Available in two sizes: 140g and 520g

GEL ALIMENTAIRE PRÊT À L'EMPLOI SANS GLUTEN POUR CRÉER DES DENTELLES ET AUTRES DÉCORATIONS PARFAITES ET ÉLASTIQUE.

Ready Lace est un gel colorable permettant de réaliser de belles dentelles en sucre pour la décoration de gâteaux, biscuits, etc. Extrêmement simple à utiliser, il permet de décorer gâteaux et desserts avec un véritable effet tridimensionnel. Disponible en deux formats: 140g e 520g.



READY LACE - 140 g

Item: 99.531.01.0001
Size: 140g
Pcs/master: 6
EAN: 8051085341474



READY LACE - 520 g

Item: 99.531.03.0001
Size: 500g
Pcs/master: 10
EAN: 8051085372331



MODO D'USO

HOW TO USE - MODE D'EMPLOI



NO-STICK DECOR



Staccante alimentare spray per ungere teglie, stampi, forme e piastre.

Food grade no-stick spray for greasing ovens, pans, moulds and hot plates.

Agent de démoulage alimentaire en spray pour graisser les plaques de cuisson, les moules et les assiettes.

Item: 99.518.99.0001

Size: 200ml

Pcs/master: 6

EAN: 8051085344383



COOLER DECOR



Raffreddante rapido in spray, per fissare prodotti a base di zucchero e composizioni di cioccolato, garantendo una presa rapida ed istantanea. Con cannucchia, ideale per zucchero e cioccolato.

Rapid cooling spray, to fix sugar-based products and chocolate compositions, ensuring a quick and instant set. With straw, ideal for sugar and chocolate.

Spray à refroidissement rapide, pour fixer les produits sucrés et les compositions chocolatées, assurant une prise rapide et instantanée. Avec paille, idéal pour le sucre et le chocolat.

Item: 99.517.99.0001

Size: 400ml

Pcs/master: 9

EAN: 8051085344420



BRILL DECOR



Lucidante alimentare da pasticceria. Ideale per lucidare cioccolato, pasta di zucchero, marzipane, cioccolato plastico.

Food polish for confectionery. Ideal for polishing chocolate, sugar paste, marzipan, plastic chocolate.

Vernis alimentaire pour la confiserie. Idéal pour polir le chocolat, la pâte à sucre, la pâte d'amande, le chocolat plastique.

Item: 99.533.99.0001

Size: 400ml

Pcs/master: 9

EAN: 8051085371013





SCIROPPO DI GLUCOSIO

Liquido denso, conferisce elasticità alla pasta di zucchero, cioccolato plastico, fondant. Viene utilizzato anche per le caramelle.

Thick liquid, gives elasticity to the sugar paste, plastic chocolate, fondant. It is also used for candies and sweets.

Liquide épais, donne de l'élasticité à la pâte de sucre, le chocolate en plastique, fondant. Il est également utilisé pour des bonbons.

Item: 99.531.02.0001

Size: 230g

Pcs/master: 6

EAN: 8051085340149



AGAR AGAR

L'agar agar viene utilizzato come gelificante naturale all'interno di molte preparazioni, soprattutto nella cucina vegetariana e vegana, ma anche in quella tradizionale nella preparazione di gelatine sia per i dolci, come la panna cotta, oppure per preparazioni salate, come gli aspic. Non altera in nessun modo il sapore delle pietanze in cui viene utilizzato ed è completamente vegetale.

The agar agar is used as a natural gelling agent in many preparations, especially in vegetarian and vegan foods, but also in the traditional ones in the preparation of the gelatin for sweets, such as "crème brûlée" or for salty preparations such as aspic. It does not alter the flavor of the foods in any way in which it is used and is completely vegetable.

L'agar-agar est utilisé comme agent gélifiant naturel dans de nombreuses préparations, en particulier dans la cuisine végétarienne et végétalienne, mais aussi dans celui traditionnel dans la préparation des gélatine pour les gâteaux, comme la crème brûlée, ou pour les préparations salées, comme aspic. Il ne modifie en rien la saveur de la nourriture dans laquelle il est utilisé et est entièrement végétale.

Item: 99.528.01.0001

Size: 40g

Pcs/master: 6

EAN: 8051085345373



CMC

CMC: Viene utilizzata come addensante, ma anche come agente anti-aggregante ed emulsionante.

CMC: It is used as a thickener, but also as an anti-aggregating and amulsifier agent.

CMC: Est utilisée comme épaississant, mais aussi comme agent d'anti agrégation et émulsifiant.

Item: 99.529.01.0001

Size: 40g

Pcs/master: 6

EAN: 8051085345403



ISOMALTO



Item: 99.527.01.0001

Size: 500g

Pcs/master: 6

EAN: 8051085344406



L'isomalto è un sostituto naturale dello zucchero. Si tratta di un disaccaride composto dai due zuccheri glucosio e mannitolo. L'isomalto non ha l'indesiderato "effetto di raffreddamento" (cooling effect) proprio di altri zuccheri alcolici. Può essere utilizzato anche per la scultura di zucchero ed alcuni lo preferiscono in quanto cristallizza più lentamente. È trasparente (in questo differisce dal caramello) quindi potete lasciarlo così o colorarlo (aggiungendo dei coloranti in gel prima di scioglierlo). Il sapore è uguale a quello del normale zucchero. Raffreddandosi più lentamente del caramello, si ha un po' più di tempo per modellare le decorazioni.

Isomalt is a natural substitute for sugar, which is mainly used for its physical characteristics similar to those of sugar. Isomalt is a disaccharide composed of two sugars glucose and mannitol. The isomalt can be dissolved either in the microwave or in a pan with double bottom. Isomalt is transparent (this differs from caramel) then you can either leave as it is or colour it (put the gel colour before it is dissolved). The flavour is equal to that of regular sugar. It cools more slowly than caramel and you have a little more time to shape the decorations.

L'isomalt est un substitut naturel du sucre, qui est principalement utilisé pour ses caractéristiques physique similaires à celles du sucre. L'isomalt est un disaccharide composé de deux sucres glucose et le mannitol. L'isomalt n'a pas indésirable "effet de refroidissement" que les autres sucres. L'isomalt peut également être utilisé pour la sculpture du sucre et un peu le préfère à sucre parce qu'il cristallise plus lentement. L'isomalt est transparent (ceci diffère de caramel) alors vous pouvez laisser aussi ou le colorer et mettre le gel colorant avant la dissolution. L'arôme est égale à celui du sucre ordinaire. Il est vrai qu'il se refroidit plus lentement que le caramel, donc vous avez un peu de plus de temps pour façonner les décorations.



Item: 99.526.01.0001

Size: 40g

Pcs/master: 6

EAN: 8051085345502



GOMMA DI XANTHANO

Utilizzata come emulsionante e addensante per tutti i tipi di alimenti, dalle salse fino ai dolci e bevande.

Spume e mousse: in ricette dolci come la panna montata, la meringa o anche mousse ne aumenta la stabilità, facendole "scendere" più lentamente. In questo caso, 1g per litro sarà sufficiente.

Gelati: è un'opzione perfetta per aumentare la sua consistenza, poiché è necessario usare meno grassi nelle ricette. Agisce anche come emulsionante, favorendo la formazione di microbolle d'aria che conferiscono volume e leggerezza al gelato.

Dolci e prodotti da forno o pasticceria: ti sarà di grande aiuto per aumentare la compattezza e migliorare la consistenza di qualsiasi pane, dolce, biscotto o torta che vorrai preparare.

Used as an emulsifier and thickener for all kinds of foods, from sauces to desserts and drinks.

Foams and mousses: in sweet recipes such as whipped cream, meringue or even mousses it increases their stability, making them 'go down' more slowly. In this case, 1g per litre will be sufficient.

Ice cream: this is a perfect option to increase its consistency, as less fat needs to be used in recipes. It also acts as an emulsifier, favouring the formation of micro air bubbles that give ice cream volume and lightness.

Sweets and baked goods or pastries: it will help to increase the firmness and improve the consistency of any bread, cake, biscuit or pie you wish to prepare. Utilisé comme émulsifiant et épaississant pour toutes sortes d'aliments, des sauces aux desserts et aux boissons.

Mousses: dans les recettes sucrées telles que les crèmes fouettées, les meringues ou même les mousses, il augmente leur stabilité, ce qui les fait "descendre" plus lentement. Dans ce cas, 1 g par litre sera suffisant.

Crème glacée: c'est une option parfaite pour augmenter sa consistance, car il faut utiliser moins de matières grasses dans les recettes. Il agit également comme un émulsifiant, favorisant la formation de microbulles d'air qui donnent à la crème glacée volume et légèreté.

Sucreries et produits de boulangerie ou de pâtisserie: il aidera à augmenter la fermeté et à améliorer la consistance de tout pain, gâteau, biscuit ou tarte que vous souhaitez préparer.



FOGLIA ARGENTO 999/1000 80x80 mm

5 fogli d'argento alimentare 80 x 80 mm
5 edible silver sheets 80 x 80 mm
5 feuilles d'argent alimentaire 80 x 80 mm

Item: 99.535.02.0001

Pcs/master: 50

EAN: 8051085375578



FOGLIA ORO 23 K 80x80 mm

5 fogli oro edibile 23k
5 23k gold edible sheets
5 feuilles d'or alimentaire 23 carats

Item: 99.535.01.0001

Pcs/master: 50

EAN: 8051085375561

